

# Toolholder Program

- AS-200 (12 ST)
- AS-200 (15 ST)
- NTJ-100
- NTY<sup>3</sup>-100, WY-100 II (12 ST)
- NTY<sup>3</sup>-150, 250, WY-150, 250
- SC-100
- SC-200
- SC-250
- SC-300 II
- SC-450
- Super NTJ
- Super NTJX
- Super NTX
- TW-30
- WT-100
- WT-150, WT-150 II, WT-250 II
- WT-300

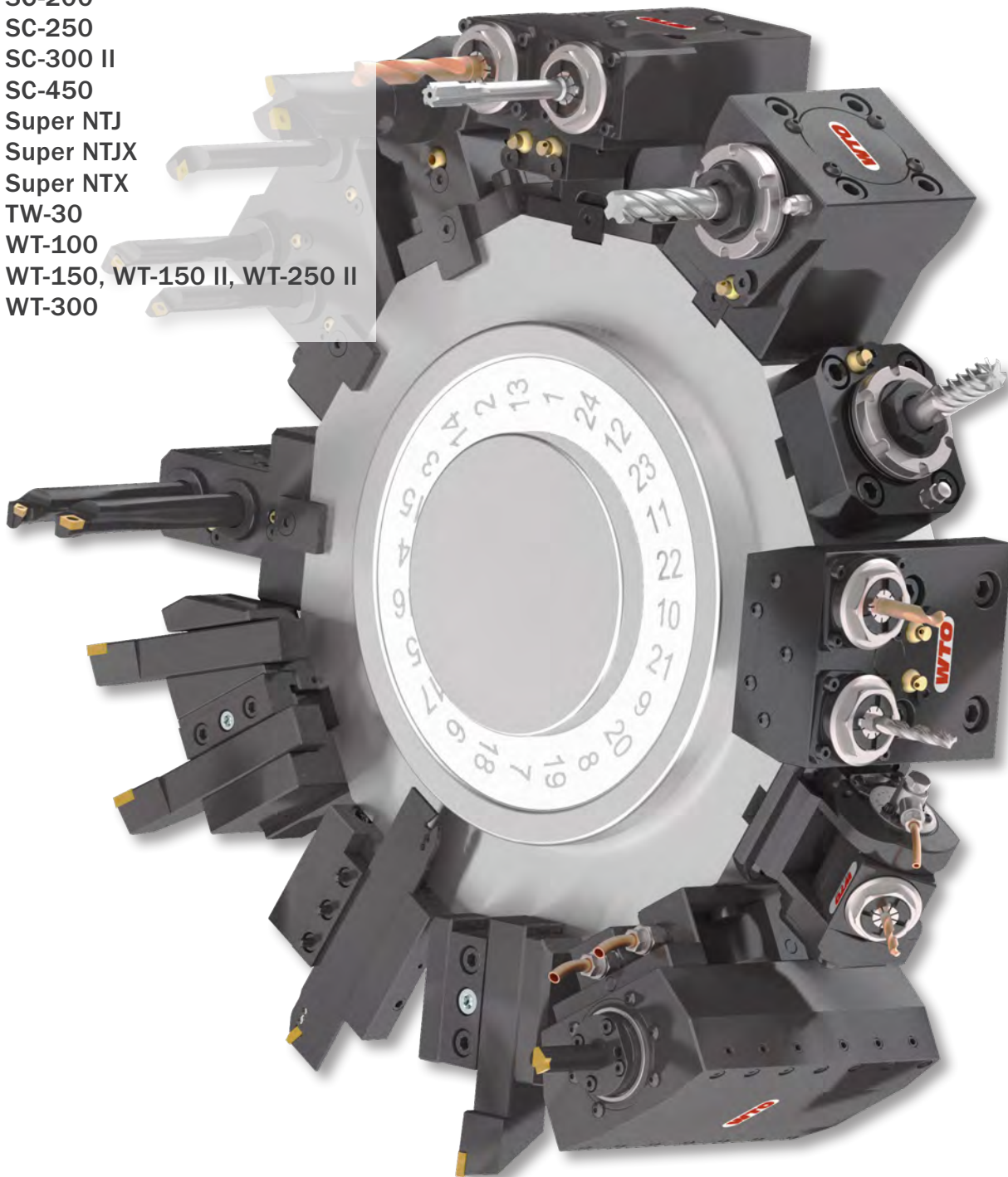

# QuickFlex<sup>®</sup>

The new quick change system for high performance and precision.

Minimal investment, maximal expandability.



Designed  
for  
BMT Turrets

AS-200 (12 ST)	Page	4 - 6
AS-200 (15 ST)	Page	7 - 9
NTJ-100	Page	10 - 12
NTY <sup>3</sup> -100, WY-100 II (12 ST)	Page	13 - 15
NTY <sup>3</sup> -150, 250, WY-150, 250	Page	16 - 19
SC-100	Page	20 - 22
SC-200	Page	23 - 25
SC-250	Page	26 - 29
SC-300 II	Page	30 - 32
SC-450	Page	33 - 33
Super NTJ	Page	34 - 36
Super NTJX	Page	37 - 39
Super NTX	Page	40 - 42
TW-30	Page	43 - 43
WT-100	Page	44 - 46
WT-150, WT-150 II, WT-250 II	Page	47 - 50
WT-300	Page	51 - 53
Reduction sleeves	Page	54 - 54
Collets	Page	55 - 57

**EC = External coolant supply**  
**HP-IC = High pressure internal coolant supply through cutting tool**  
**IC 80 bar = Internal and external coolant supply**  
 Max. coolant pressure = 80 bar  
**IC 30 bar = Internal and external coolant supply**  
 Max. coolant pressure = 30 bar  
 Only use filtered coolant fluid (max. particle size = 50 µm)  
 Do not run without coolant  
 Do not use for machining abrasive materials such as cast iron, etc.

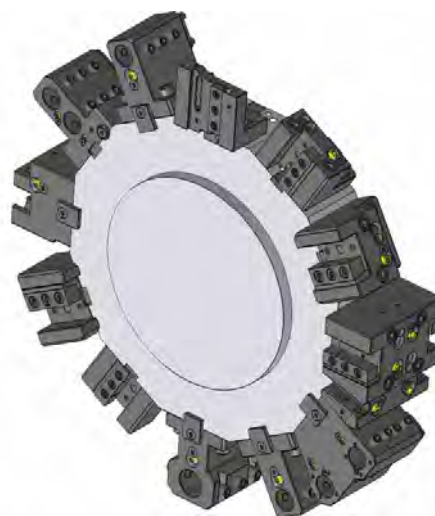
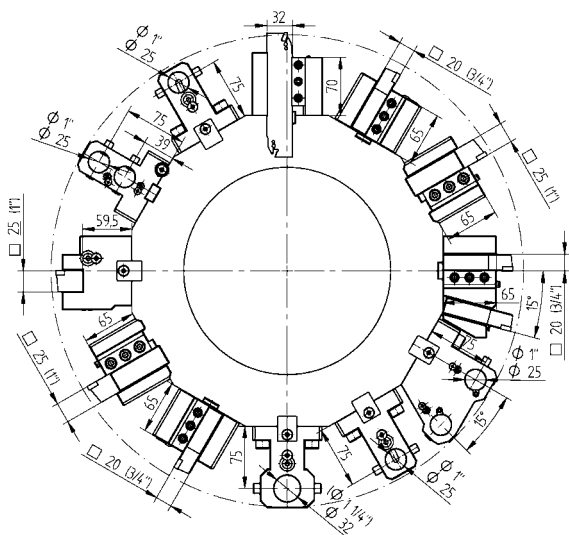



Static Toolholders - Standard Program

- 

**OD cutting holder**  
 20 48-108585  
 3/4" 48-108586  
 25 48-106720
- 

**OD cutting holder, HP-IC**  
 25 48-106720-HP IC 80 bar  
 1" 48-106730-HP IC 80 bar
- 

**OD cutting holder, both sides**  
 20 48-108460  
 3/4" 48-108588
- 

**Face cutting holder**  
 20 48-108590  
 3/4" 48-108591
- 

**Face cutting holder**  
 25 48-107758  
 1" 48-107759
- 

**Combination toolholder**  
 Ø 25 48-107842  
 Ø 1" 48-107879  
 Ø 32 48-106727  
 1 1/4" 48-106734

Static Toolholders - Enhanced Program

- 

**OD cutting holder, double, 24 station (only for turret size 375)**  
 20 48-108784 EC  
 3/4" 48-108785 EC
- 

**OD cutting holder, both sides, double, 24 station (only for turret size 375)**  
 20 48-108786 EC  
 3/4" 48-108787 EC
- 

**Cut-off holder**  
 SH 32 48-99637
- 

**Cut-off holder, HP-IC**  
 SH 32 48-102276R IC 80 bar  
 SH 32 48-102276L IC 80 bar
- 

**Cut-off holder, adjustable**  
 SH 32 48-110366 EC
- 

**Cut-off holder, adjustable, HP-IC**  
 SH 32 48-109656L IC 80 bar  
 343-810100L87  
 SH 32 48-109656R IC 80 bar  
 343-810100R87
- 

**Combination toolholder, double**  
 Ø 25 48-108792 IC 80 bar  
 Ø 1" 48-108793 IC 80 bar
- 

**Combination toolholder, both sides, double, 24 station (only for turret size 375)**  
 20 48-108794 EC  
 Ø 1" 48-108795 EC



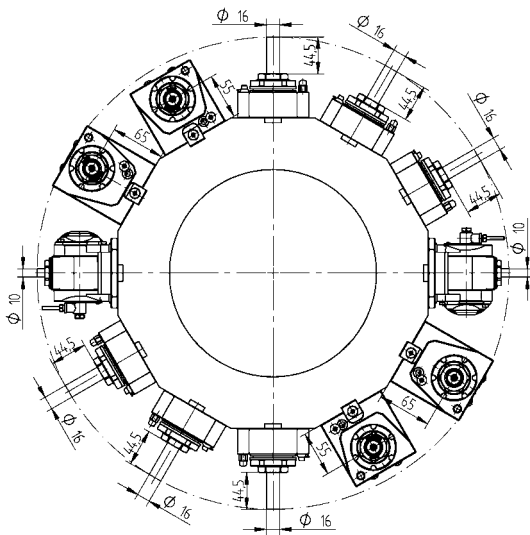

Driven Toolholders - QuickFlex®



**Straight drill/milling unit**

**ER-25 QF** 420125022-55 1:1 EC  
0067725000

**ER-25 QF** 420125023-55 1:1 IC 80 bar  
0067725000



**Right angle drill/milling unit, LF=55**

**ER-25 QF** 420525087-55 1:1 EC  
0067725000

**ER-25 QF** 420525088-55 1:1 IC 80 bar  
0067725000



**Right angle drill/milling unit, LF=65**

**ER-25 QF** 420525085-55 1:1 EC  
0067725000

**ER-25 QF** 420525086-55 1:1 IC 80 bar  
0067725000



**Right angle drill/milling unit, both sides, LF=55**

**ER-25 QF** 420525069-55 1:1 EC  
0067725000



**Right angle drill/milling unit, both sides, LF=65**

**ER-25 QF** 420525077-55 1:1 EC  
0067725010

Driven Toolholders - Enhanced Program



**Straight drill/milling unit**

**ER 32** 410120002-55 1:1 EC  
0067825000

**ER 32** 410120003-55 1:1 IC 80 bar  
0067825000



**Straight milling unit**

**Ø 22** 410222002-55 1:1 EC  
00675000483

**Ø 3/4"** 410219000-55 1:1 EC  
00675000854



**Straight offset drill/milling unit**

**ER 25** 410116027-55 1:1 EC  
00675000932

**ER 25** 410116028-55 1:1 IC 80 bar  
00675000932

**ER 20** 410113006-55 1:2 EC  
00675000939

**ER 20** 410113004-55 1:2 IC 80 bar  
00675000939

**ER 16** 410410000-55 1:3 EC  
00675000937

**ER 16** 410410001-55 1:3 IC 80 bar  
00675000937

**ER 25** 410116021-55 2:1 EC  
00675000932

**ER 25** 410116022-55 2:1 IC 80 bar  
00675000932

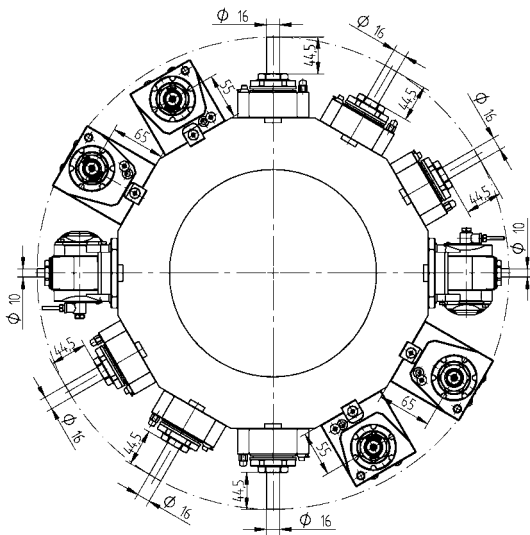

Driven Toolholders - Enhanced Program

Driven Toolholders - Enhanced Program



**Right angle drill/milling unit, LF=65**

<b>ER 32</b>	410520045-55	1:1	EC
	0067825000		
<b>ER 32</b>	410520046-55	1:1	IC 80 bar
	0067825000		
<b>ER-20 QF</b>	420520029-55	1:2	EC
	0067720001		
<b>ER-20 QF</b>	420520030-55	1:2	IC 80 bar
	0067720001		
<b>ER 16</b>	410810022-55	1:3	EC
	00675000841		
<b>ER 16</b>	410810023-55	1:3	IC 80 bar
	00675000841		
<b>ER-25 QF</b>	420525055-55	2:1	EC
	0067725000		
<b>ER-25 QF</b>	420525056-55	2:1	IC 80 bar
	0067725000		

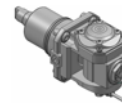

**Adjustable angle drill/milling unit**

<b>ER 16</b>	411010001-55	1:1	EC
	00675000902		
<b>ER 16</b>	411010002-55	1:1	IC 80 bar
	00675000902		
<b>ER 11</b>	411007003-55	1:2	EC
	00675000914		
<b>ER 11</b>	411007004-55	1:2	IC 80 bar
	00675000914		



**Right angle milling unit with combination mill arbor DIN 6358, LF=65**

<b>Ø 22</b>	410622013-55	1:1	EC
	00675000483		
<b>Ø 22</b>	410622007-55	2:1	EC
	00675000483		
<b>Ø 3/4"</b>	410619008-55	1:1	EC
	00675000483		

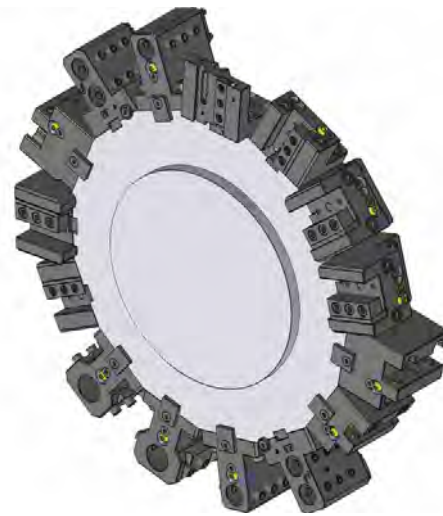
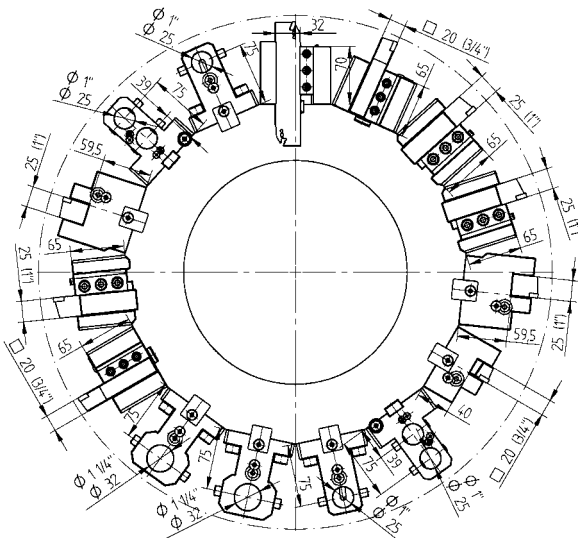



Static Toolholders - Standard Program

Static Toolholders - Enhanced Program

- 

**OD cutting holder**  
 20 48-108585  
 3/4" 48-108586  
 25 48-106720
- 

**OD cutting holder, HP-IC**  
 25 48-106720-HP IC 80 bar  
 1" 48-106730-HP IC 80 bar
- 

**OD cutting holder, both sides**  
 20 48-108460  
 3/4" 48-108588
- 

**Face cutting holder**  
 20 48-108590  
 3/4" 48-108591
- 

**Face cutting holder**  
 25 48-107758  
 1" 48-107759
- 

**Combination toolholder**  
 Ø 25 48-107842  
 Ø 1" 48-107879  
 Ø 32 48-106727  
 1 1/4" 48-106734

- 

**Cut-off holder**  
 SH 32 48-99637
- 

**Cut-off holder, HP-IC**  
 SH 32 48-102276R IC 80 bar  
 SH 32 48-102276L IC 80 bar
- 

**Cut-off holder, adjustable**  
 SH 32 48-110366 EC
- 

**Cut-off holder, adjustable, HP-IC**  
 SH 32 48-109656L IC 80 bar  
 343-810100L87  
 SH 32 48-109656R IC 80 bar  
 343-810100R87
- 

**Combination toolholder, double**  
 Ø 25 48-108792 IC 80 bar  
 Ø 1" 48-108793 IC 80 bar

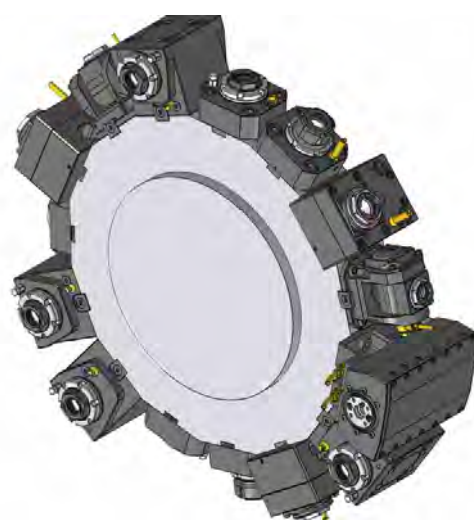
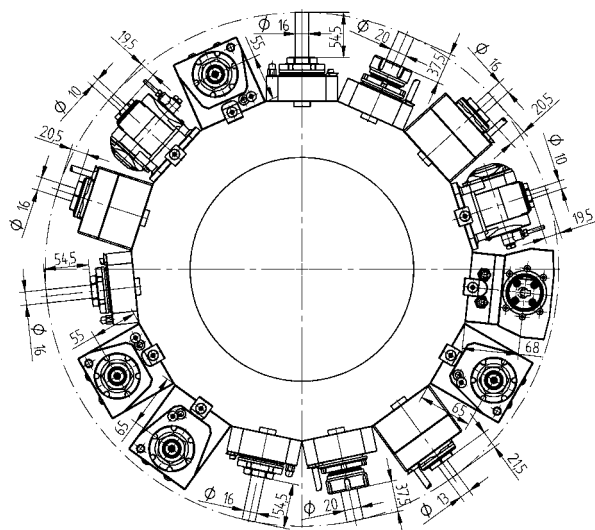



Driven Toolholders - QuickFlex®

- 

**Straight drill/milling unit**  
**ER-25 QF** 420125022-55 1:1 EC  
 0067725000  
**ER-25 QF** 420125023-55 1:1 IC 80 bar  
 0067725000
- 

**Right angle drill/milling unit, LF=55**  
**ER-25 QF** 420525087-55 1:1 EC  
 0067725000  
**ER-25 QF** 420525088-55 1:1 IC 80 bar  
 0067725000
- 

**Right angle drill/milling unit, LF=65**  
**ER-25 QF** 420525085-55 1:1 EC  
 0067725000  
**ER-25 QF** 420525086-55 1:1 IC 80 bar  
 0067725000
- 

**Right angle drill/milling unit, both sides, LF=55**  
**ER-25 QF** 420525069-55 1:1 EC  
 0067725000
- 

**Right angle drill/milling unit, both sides, LF=65**  
**ER-25 QF** 420525077-55 1:1 EC  
 0067725010

Driven Toolholders - Enhanced Program

- 

**Straight drill/milling unit**  
**ER 32** 410120002-55 1:1 EC  
 0067825000  
**ER 32** 410120003-55 1:1 IC 80 bar  
 0067825000
- 

**Straight milling unit**  
**Ø 22** 410222002-55 1:1 EC  
 00675000483  
**Ø 3/4"** 410219000-55 1:1 EC  
 00675000854
- 

**Straight offset drill/milling unit**  
**ER 25** 410116027-55 1:1 EC  
 00675000932  
**ER 25** 410116028-55 1:1 IC 80 bar  
 00675000932  
**ER 20** 410113006-55 1:2 EC  
 00675000939  
**ER 20** 410113004-55 1:2 IC 80 bar  
 00675000939  
**ER 16** 410410000-55 1:3 EC  
 00675000937  
**ER 16** 410410001-55 1:3 IC 80 bar  
 00675000937  
**ER 25** 410116021-55 2:1 EC  
 00675000932  
**ER 25** 410116022-55 2:1 IC 80 bar  
 00675000932



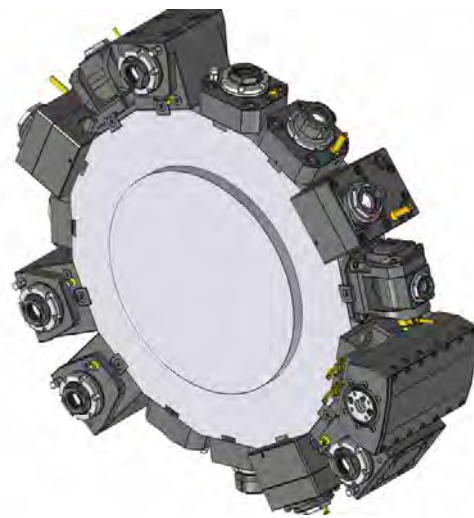
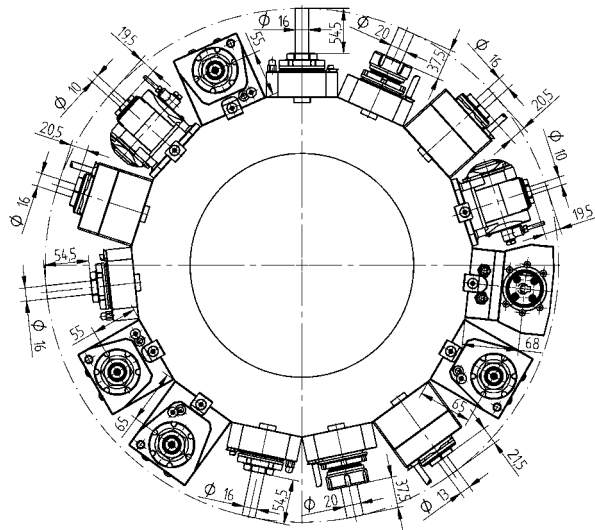

Driven Toolholders - Enhanced Program

Driven Toolholders - Enhanced Program



**Right angle drill/milling unit, LF=65**

<b>ER 32</b>	410520045-55	1:1	EC
	0067825000		
<b>ER 32</b>	410520046-55	1:1	IC 80 bar
	0067825000		
<b>ER-20 QF</b>	420520029-55	1:2	EC
	0067720001		
<b>ER-20 QF</b>	420520030-55	1:2	IC 80 bar
	0067720001		
<b>ER 16</b>	410810022-55	1:3	EC
	00675000841		
<b>ER 16</b>	410810023-55	1:3	IC 80 bar
	00675000841		
<b>ER-25 QF</b>	420525055-55	2:1	EC
	0067725000		
<b>ER-25 QF</b>	420525056-55	2:1	IC 80 bar
	0067725000		



**Right angle back set drill/milling unit, LF=65**

<b>ER 32</b>	410520007-55	1:1	EC
	00675000592		
<b>ER 32</b>	410520008-55	1:1	IC 80 bar
	00675000592		
<b>ER 32</b>	410520009-55	2:1	EC
	00675000592		
<b>ER 32</b>	410520010-55	2:1	IC 80 bar
	00675000592		



**Adjustable angle drill/milling unit**

<b>ER 16</b>	411010001-55	1:1	EC
	00675000902		
<b>ER 16</b>	411010002-55	1:1	IC 80 bar
	00675000902		
<b>ER 11</b>	411007003-55	1:2	EC
	00675000914		
<b>ER 11</b>	411007004-55	1:2	IC 80 bar
	00675000914		



**Right angle milling unit with combination mill arbor DIN 6358, LF=65**

<b>Ø 22</b>	410622013-55	1:1	EC
	00675000483		
<b>Ø 22</b>	410622007-55	2:1	EC
	00675000483		
<b>Ø 3/4"</b>	410619008-55	1:1	EC
	00675000483		



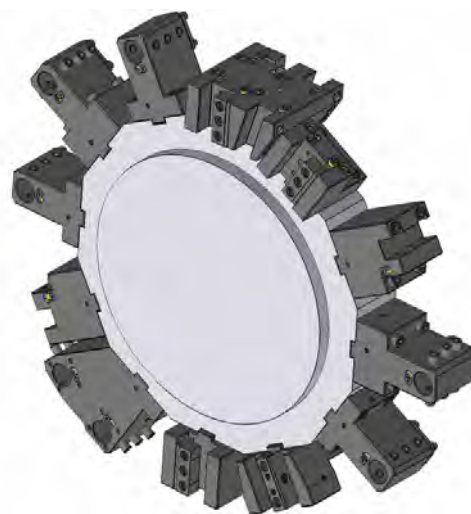
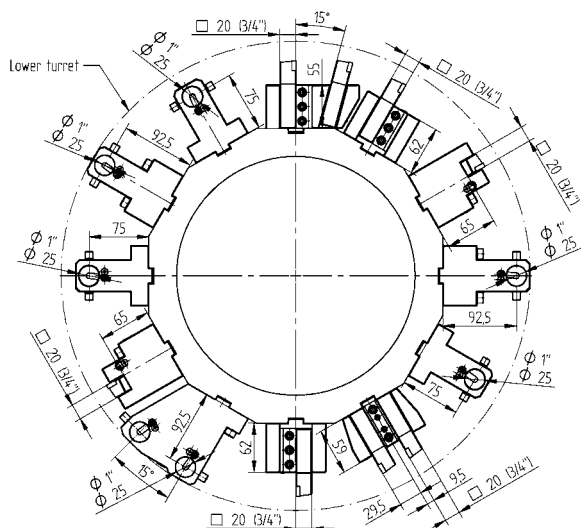

**Broaching unit for ID and OD**

<b>TN765050</b>	414532003-55	1:1	EC
-----------------	--------------	-----	----





Static Toolholders - Standard Program

- 

**OD cutting holder**  
 20 48-101470  
 Z90-86304-00  
 3/4" 48-104496
- 

**OD cutting holder, HP-IC**  
 20 48-101470-HP IC 80 bar  
 3/4" 48-104496-HP IC 80 bar
- 

**OD cutting holder, both sides**  
 20 48-101471  
 Z90-86303-00  
 3/4" 48-104755
- 

**Face cutting holder**  
 20 48-102352  
 Z90-86301-00  
 3/4" 48-104735
- 

**Combination toolholder, LF=75**  
 Ø 25 48-101472  
 Z90-86302-00  
 Ø 1" 48-104526
- 

**Combination toolholder, LF=92,5**  
 Ø 25 48-106613  
 Ø 1" 48-106614

Static Toolholders - Enhanced Program

- 

**OD cutting holder, double, Y axis**  
 20 48-101473  
 Z90-86548-00  
 3/4" 48-104523
- 

**OD cutting holder, both sides, double, 24 station (only for turret size 370)**  
 20 48-108104 EC  
 3/4" 48-108148 EC
- 

**Cut-off holder**  
 SH 26 48-100419  
 Z90-86307-00
- 

**Cut-off holder, HP-IC**  
 SH 26 48-102274R IC 80 bar  
 SH 26 48-102274L IC 80 bar  
 SH 32 48-112233R IC 80 bar  
 343-810100R95  
 SH 32 48-112233L IC 80 bar  
 343-810100L95
- 

**Combination toolholder, universal, double, 24 station (only for turret size 300)**  
 Ø 25 48-107985 IC 80 bar  
 Ø 1" 48-108111 IC 80 bar
- 

**Combination toolholder, universal, double, 24 station (only for turret size 370)**  
 Ø 25 48-108103 IC 80 bar  
 Ø 1" 48-108147 IC 80 bar

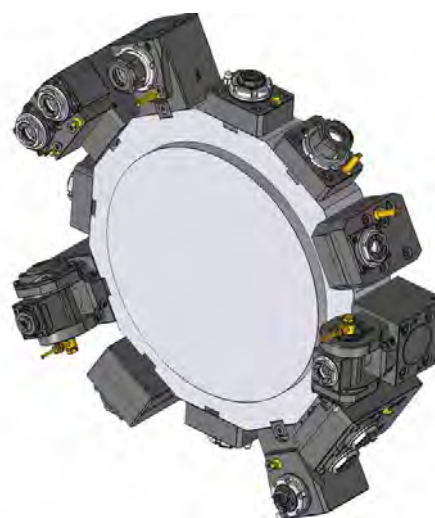
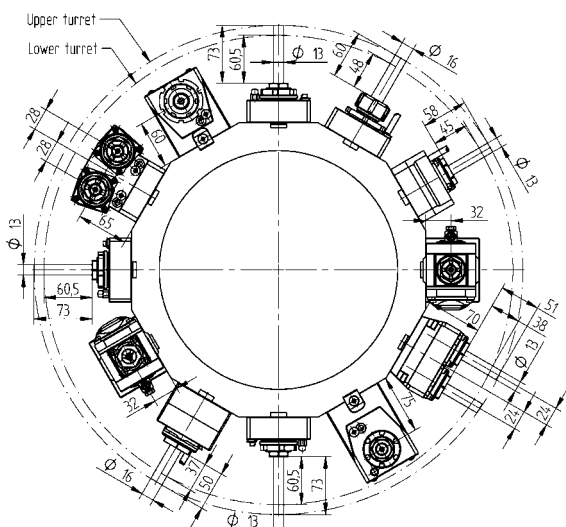

Driven Toolholders - QuickFlex®

	<b>Straight drill/milling unit</b>			
	<b>ER-20 QF</b>	420120010-44 Z90-86300-00 0067720000	1:1	EC
	<b>ER-20 QF</b>	420120011-44 0067720000	1:1	IC 80 bar
	<b>Right angle drill/milling unit, LF=60</b>			
	<b>ER-20 QF</b>	420520010-44 Z90-86299-00 0067720000	1:1	EC
	<b>ER-20 QF</b>	420520011-44 0067720000	1:1	IC 80 bar
	<b>Right angle drill/milling unit, LF=75</b>			
	<b>ER-20 QF</b>	420520015-44 0067720000	1:1	EC
	<b>ER-20 QF</b>	420520016-44 0067720000	1:1	IC 80 bar
		<b>Right angle drill/milling unit, both sides, LF=60</b>		
<b>ER-20 QF</b>		420520012-44 0067720000	1:1	EC

Driven Toolholders - Enhanced Program

	<b>Straight drill/milling unit</b>			
	<b>ER 25</b>	410116004-44 Z90-86305-00 00675000720	1:1	EC
	<b>ER 25</b>	410116002-44 00675000720	1:1	IC 80 bar
	<b>Straight offset drill/milling unit</b>			
<b>ER 20</b>		410113004-44 Z90-89788-00 00675000939	1:2	EC
	<b>ER 16</b>	410110002-44 00675000937	1:3	EC
	<b>ER 25</b>	410116005-44 00675000932	1.5:1	EC
	<b>Right angle drill/milling unit, LF=60</b>			
	<b>ER 25</b>	410516005-44 Z90-86306-00 00675000720	1:1	EC
	<b>ER 25</b>	410516006-44 00675000720	1:1	IC 80 bar
		<b>ER 20</b>	410513002-44 Z90-89789-00 00675000833	1:2
<b>ER 20</b>		410513003-44 00675000833	1:2	IC 80 bar
	<b>ER 16</b>	410810006-44 00675000841	1:3	EC
	<b>ER 16</b>	410810007-44 00675000841	1:3	IC 80 bar
	<b>ER 25</b>	410516002-44 00675000720	2:1	EC
	<b>ER 25</b>	410516003-44 00675000720	2:1	IC 80 bar

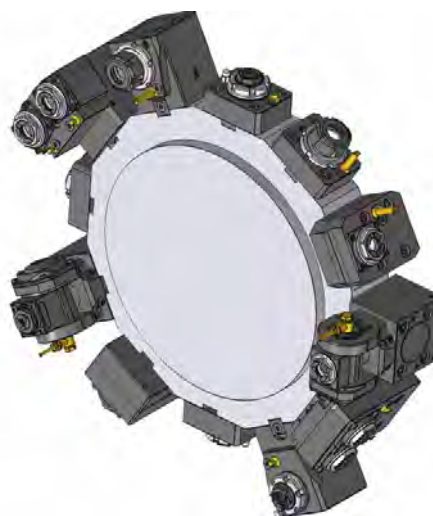
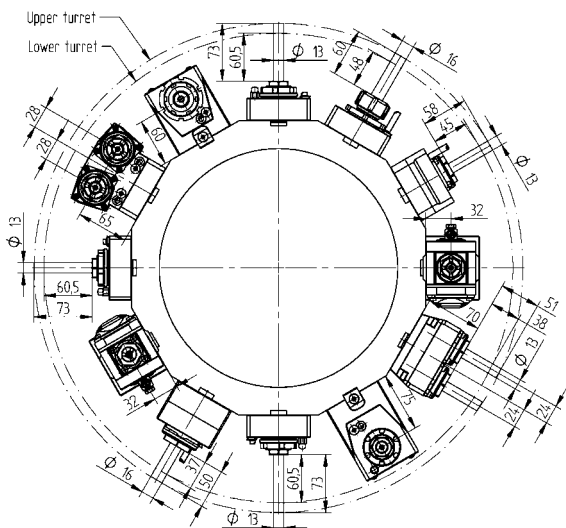

Driven Toolholders - Enhanced Program



**Right angle milling unit with combination mill arbor DIN 6358, LF=60**

<b>Ø 22</b>	410622000-44	1:1	EC
	00675000483		
<b>Ø 22</b>	410622001-44	2:1	EC
	00675000483		



**Adjustable angle drill/milling unit**

<b>ER 16</b>	411010004-44	1:1	EC
	Z90-89787-00		
	00675000902		
<b>ER 16</b>	411010005-44	1:1	IC 80 bar
	00675000902		
<b>ER 11</b>	411007006-44	1:2	EC
	00675000914		
<b>ER 11</b>	411007007-44	1:2	IC 80 bar
	00675000914		



**Straight drill/milling unit, double, Y axis**

<b>ER 20</b>	413002003-44	1:1	EC
	00675000939		
<b>ER 20</b>	413002004-44	1:1	IC 80 bar
	00675000939		



**2-spindle - Right angle drill/milling unit, Y axis**

<b>ER 20</b>	413502004-44	1:1	EC
	00675000939		
<b>ER 20</b>	413502005-44	1:1	IC 80 bar
	00675000939		



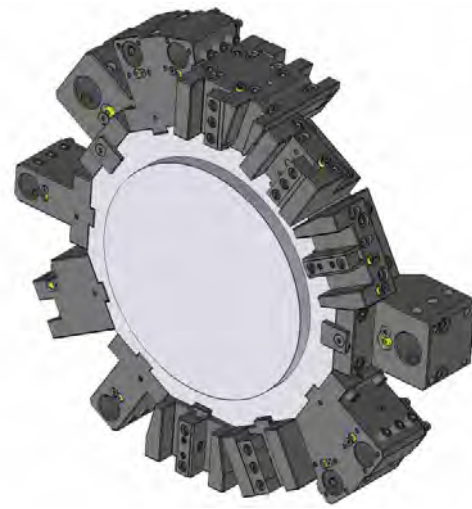
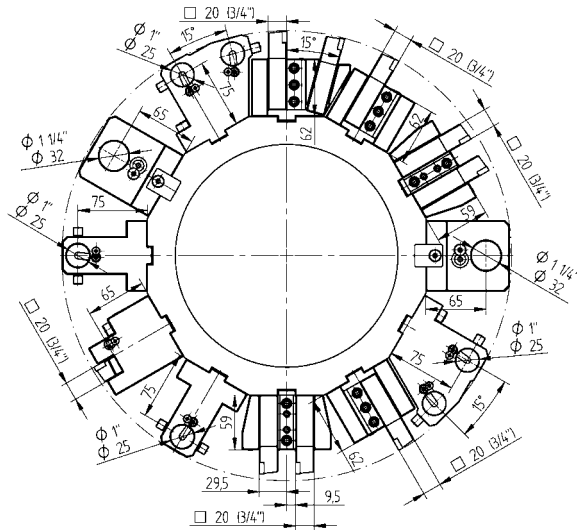



Static Toolholders - Standard Program

- 

**OD cutting holder**  
 20      48-101470  
          Z90-86304-00  
 3/4"     48-104496
- 

**OD cutting holder, HP-IC**  
 20      48-101470-HP    IC 80 bar  
 3/4"     48-104496-HP    IC 80 bar
- 

**OD cutting holder, both sides**  
 20      48-101471  
          Z90-86303-00  
 3/4"     48-104755
- 

**Face cutting holder**  
 20      48-102352  
          Z90-86301-00  
 3/4"     48-104735
- 

**Combination toolholder, LF=75**  
 Ø 25     48-101472  
          Z90-86302-00  
 Ø 1"     48-104526
- 

**Combination toolholder**  
 Ø 32     48-107155  
 Ø 1 1/4" 48-107260

Static Toolholders - Enhanced Program

- 

**OD cutting holder, double, Y axis**  
 20      48-101473  
          Z90-86548-00  
 3/4"     48-104523
- 

**OD cutting holder, both sides, double, 24 station (only for turret size 300)**  
 20      48-107973        EC  
 3/4"     48-108110        EC
- 

**Cut-off holder**  
 SH 26    48-100419  
               Z90-86307-00
- 

**Cut-off holder, HP-IC**  
 SH 26    48-102274R        IC 80 bar  
 SH 26    48-102274L        IC 80 bar  
 SH 32    48-112233R        IC 80 bar  
               343-810100R95  
 SH 32    48-112233L        IC 80 bar  
               343-810100L95
- 

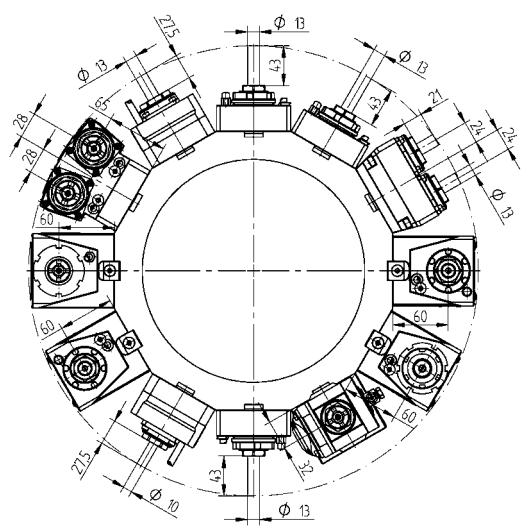

**Combination toolholder, universal, double, 24 station (only for turret size 300)**  
 Ø 25     48-107985        IC 80 bar  
 Ø 1"     48-108111        IC 80 bar





Driven Toolholders - QuickFlex®

- 



**Straight drill/milling unit**

<b>ER-20 QF</b>	420120010-44	1:1	EC
	Z90-86300-00		
	 0067720000		
<b>ER-20 QF</b>	420120011-44	1:1	IC 80 bar
	Z90-86300-00		
	 0067720000		
  
- 



**Straight drill/milling unit (8000 RPM)**

<b>ER-20 QF</b>	420120010-44-S	1:1	EC
	Z90-86300-00		
	 0067720000		
<b>ER-20 QF</b>	420120011-44-S	1:1	IC 80 bar
	Z90-86300-00		
	 0067720000		
  
- 

**Right angle drill/milling unit, LF=60**

<b>ER-20 QF</b>	420520010-44	1:1	EC
	Z90-86299-00		
	 0067720000		
<b>ER-20 QF</b>	420520011-44	1:1	IC 80 bar
	Z90-86299-00		
	 0067720000		
  
- 

**Right angle drill/milling unit, LF=60, (8000 RPM)**

<b>ER-20 QF</b>	420520010-44-S	1:1	EC
	Z90-86299-00		
	 0067720000		
<b>ER-20 QF</b>	420520011-44-S	1:1	IC 80 bar
	Z90-86299-00		
	 0067720000		
  
- 



**Right angle drill/milling unit, both sides, LF=60**

<b>ER-20 QF</b>	420520012-44	1:1	EC
	Z90-86299-00		
	 0067720000		



Driven Toolholders - Enhanced Program

- 



**Straight drill/milling unit**

<b>ER 25</b>	410116004-44	1:1	EC
	Z90-86305-00		
	 00675000720		
<b>ER 25</b>	410116002-44	1:1	IC 80 bar
	Z90-86305-00		
	 00675000720		
  
- 

**Straight drill/milling unit (8000 RPM)**

<b>ER 25</b>	410116004-44-S	1:1	EC
	Z90-86305-00		
	 00675000720		
<b>ER 25</b>	410116002-44-S	1:1	IC 80 bar
	Z90-86305-00		
	 00675000720		
  
- 

**Straight offset drill/milling unit**

<b>ER 20</b>	410113004-44	1:2	EC
	Z90-89788-00		
	 00675000939		
<b>ER 16</b>	410110002-44	1:3	EC
	Z90-89788-00		
	 00675000937		
<b>ER 25</b>	410116005-44	1.5:1	EC
	Z90-89788-00		
	 00675000932		

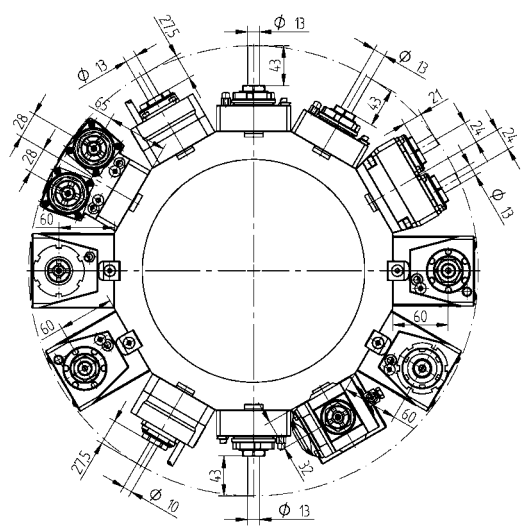

Driven Toolholders - Enhanced Program



**Right angle drill/milling unit, LF=60**

<b>ER 25</b>	410516005-44 Z90-86306-00	1:1	EC
	00675000720		
<b>ER 25</b>	410516006-44	1:1	IC 80 bar
	00675000720		
<b>ER 20</b>	410513002-44 Z90-89789-00	1:2	EC
	00675000833		
<b>ER 20</b>	410513003-44	1:2	IC 80 bar
	00675000833		
<b>ER 16</b>	410810006-44	1:3	EC
	00675000841		
<b>ER 16</b>	410810007-44	1:3	IC 80 bar
	00675000841		
<b>ER 25</b>	410516002-44	2:1	EC
	00675000720		
<b>ER 25</b>	410516003-44	2:1	IC 80 bar
	00675000720		



**Right angle drill/milling unit, LF=60, (8000 RPM)**

<b>ER 25</b>	410516005-44-S	1:1	EC
	00675000720		
<b>ER 25</b>	410516006-44-S	1:1	IC 80 bar
	00675000720		



**Right angle milling unit with combination mill arbor DIN 6358, LF=60**

<b>Ø 22</b>	410622000-44	1:1	EC
	00675000483		
<b>Ø 22</b>	410622001-44	2:1	EC
	00675000483		

Driven Toolholders - Enhanced Program



**Adjustable angle drill/milling unit**

<b>ER 16</b>	411010004-44 Z90-89787-00	1:1	EC
	00675000902		
<b>ER 16</b>	411010005-44	1:1	IC 80 bar
	00675000902		
<b>ER 11</b>	411007006-44	1:2	EC
	00675000914		
<b>ER 11</b>	411007007-44	1:2	IC 80 bar
	00675000914		



**Straight drill/milling unit, double, Y axis**

<b>ER 20</b>	413002003-44	1:1	EC
	00675000939		
<b>ER 20</b>	413002004-44	1:1	IC 80 bar
	00675000939		



**2-spindle - Right angle drill/milling unit, Y axis**

<b>ER 20</b>	413502004-44	1:1	EC
	00675000939		
<b>ER 20</b>	413502005-44	1:1	IC 80 bar
	00675000939		

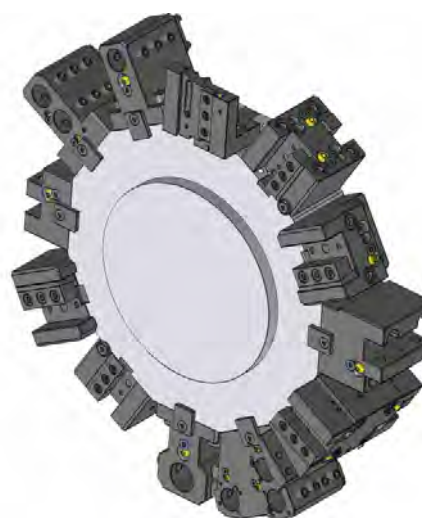
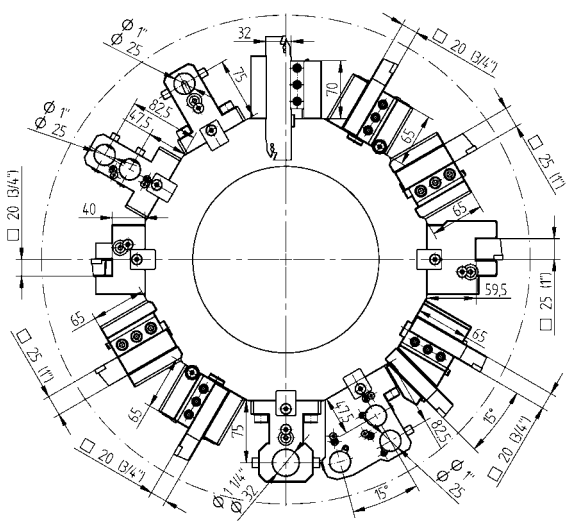

Static Toolholders - Standard Program

- 

**OD cutting holder**

20	48-108585
3/4"	48-108586
25	48-106720
- 

**OD cutting holder, HP-IC**

25	48-106720-HP	IC 80 bar
1"	48-106730-HP	IC 80 bar
- 

**OD cutting holder, both sides**

20	48-108460
3/4"	48-108588
- 

**Face cutting holder**

20	48-108590
3/4"	48-108591
- 

**Face cutting holder**

25	48-107758
1"	48-107759
- 

**Combination toolholder**

Ø 25	48-107842
Ø 1"	48-107879
Ø 32	48-106727
1 1/4"	48-106734

Static Toolholders - Enhanced Program

- 

**OD cutting holder, double, 24 station (only for turret size 340)**

20	48-108592	EC
3/4"	48-108593	EC
- 

**OD cutting holder, both sides, double, 24 station (only for turret size 340)**

20	48-108461	EC
3/4"	48-108595	EC
- 

**Cut-off holder**

SH 32	48-99637
-------	----------
- 

**Cut-off holder, HP-IC**

SH 32	48-102276R	IC 80 bar
SH 32	48-102276L	IC 80 bar
- 

**Cut-off holder, adjustable**

SH 32	48-110366	EC
-------	-----------	----
- 

**Cut-off holder, adjustable, HP-IC**

SH 32	48-109656L	IC 80 bar
	343-810100L87	
SH 32	48-109656R	IC 80 bar
	343-810100R87	
- 

**Combination toolholder, double**

Ø 25	48-108596	IC 80 bar
Ø 1"	48-108597	IC 80 bar
- 

**Combination toolholder, universal, triple, 24 station (only for turret size 340)**

Ø 25	48-108462	IC 80 bar
Ø 1"	48-108599	IC 80 bar



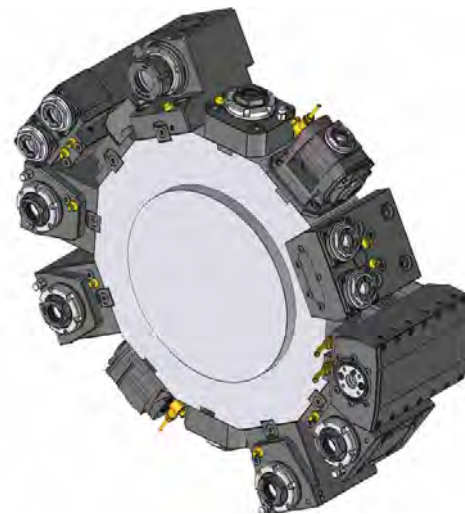
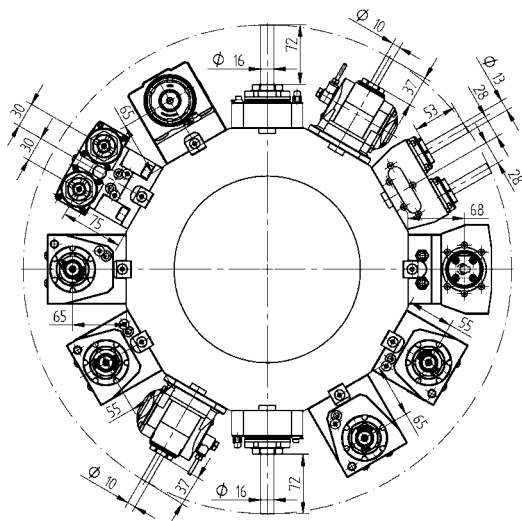

Driven Toolholders - QuickFlex®



**Straight drill/milling unit**

**ER-25 QF** 420125022-55 1:1 EC  
 0067725000

**ER-25 QF** 420125023-55 1:1 IC 80 bar  
 0067725000



**Right angle drill/milling unit, LF=55**

**ER-25 QF** 420525087-55 1:1 EC  
 0067725000

**ER-25 QF** 420525088-55 1:1 IC 80 bar  
 0067725000



**Right angle drill/milling unit, LF=65**

**ER-25 QF** 420525085-55 1:1 EC  
 0067725000

**ER-25 QF** 420525086-55 1:1 IC 80 bar  
 0067725000



**Right angle drill/milling unit, both sides, LF=55**

**ER-25 QF** 420525069-55 1:1 EC  
 0067725000



**Right angle drill/milling unit, both sides, LF=65**

**ER-25 QF** 420525077-55 1:1 EC  
 0067725010

Driven Toolholders - Enhanced Program



**Straight drill/milling unit**

**ER 32** 410120002-55 1:1 EC  
 0067825000

**ER 32** 410120003-55 1:1 IC 80 bar  
 0067825000



**Straight milling unit**

**Ø 22** 410222002-55 1:1 EC  
 00675000483

**Ø 3/4"** 410219000-55 1:1 EC  
 00675000854



**Straight offset drill/milling unit**

**ER 25** 410116027-55 1:1 EC  
 00675000932

**ER 25** 410116028-55 1:1 IC 80 bar  
 00675000932

**ER 20** 410113006-55 1:2 EC  
 00675000939

**ER 20** 410113004-55 1:2 IC 80 bar  
 00675000939

**ER 16** 410410000-55 1:3 EC  
 00675000937

**ER 16** 410410001-55 1:3 IC 80 bar  
 00675000937

**ER 25** 410116021-55 2:1 EC  
 00675000932

**ER 25** 410116022-55 2:1 IC 80 bar  
 00675000932

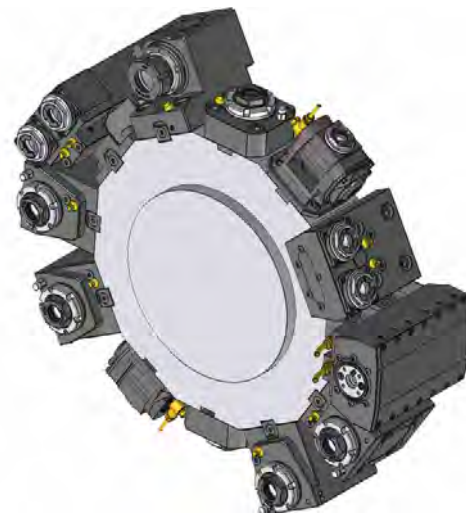
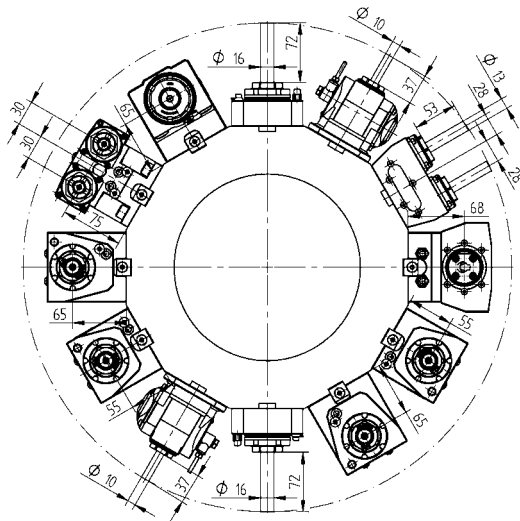

Driven Toolholders - Enhanced Program

Driven Toolholders - Enhanced Program



**Right angle drill/milling unit, LF=65**

<b>ER 32</b>	410520045-55	1:1	EC
	0067825000		
<b>ER 32</b>	410520046-55	1:1	IC 80 bar
	0067825000		
<b>ER-20 QF</b>	420520029-55	1:2	EC
	0067720001		
<b>ER-20 QF</b>	420520030-55	1:2	IC 80 bar
	0067720001		
<b>ER 16</b>	410810022-55	1:3	EC
	00675000841		
<b>ER 16</b>	410810023-55	1:3	IC 80 bar
	00675000841		
<b>ER-25 QF</b>	420525055-55	2:1	EC
	0067725000		
<b>ER-25 QF</b>	420525056-55	2:1	IC 80 bar
	0067725000		



**Right angle back set drill/milling unit, LF=65**

<b>ER 32</b>	410520007-55	1:1	EC
	00675000592		
<b>ER 32</b>	410520008-55	1:1	IC 80 bar
	00675000592		
<b>ER 32</b>	410520009-55	2:1	EC
	00675000592		
<b>ER 32</b>	410520010-55	2:1	IC 80 bar
	00675000592		



**Adjustable angle drill/milling unit**

<b>ER 16</b>	411010001-55	1:1	EC
	00675000902		
<b>ER 16</b>	411010002-55	1:1	IC 80 bar
	00675000902		
<b>ER 11</b>	411007003-55	1:2	EC
	00675000914		
<b>ER 11</b>	411007004-55	1:2	IC 80 bar
	00675000914		



**Right angle milling unit with combination mill arbor DIN 6358, LF=65**

<b>Ø 22</b>	410622013-55	1:1	EC
	00675000483		
<b>Ø 22</b>	410622007-55	2:1	EC
	00675000483		
<b>Ø 3/4"</b>	410619008-55	1:1	EC
	00675000483		



**Slitting saw unit**

<b>Type 14-2</b>	411500000-55	2.73:1	EC
	00675000489		
	160016142 Ø 16		
	160022142 Ø 22		
	160027142 Ø 27		
	160015142 Ø 5/8"		
	160019142 Ø 3/4"		
	160023142 Ø 7/8"		
	160025142 Ø 1"		



**Straight drill/milling unit, double, Y axis**

<b>ER 20</b>	413002001-55	1:1	EC
	00675000944		

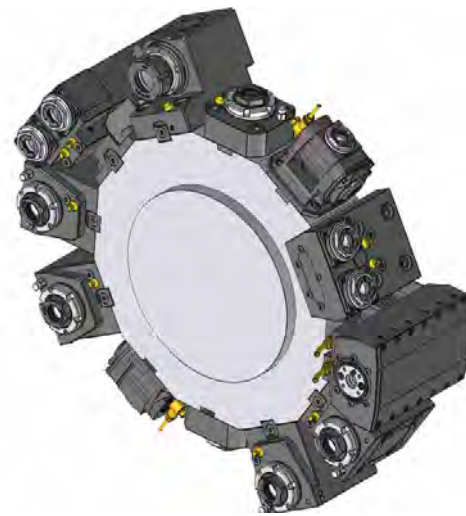
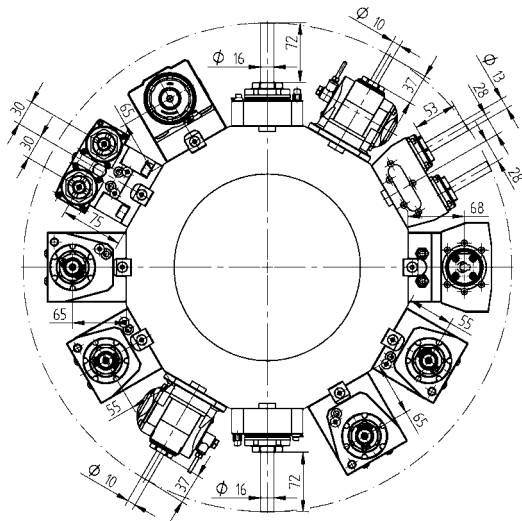

Driven Toolholders - Enhanced Program



**2-spindle - Right angle drill/milling unit, Y axis**

**ER 20** 413502012-55 1:1 EC  
 00675000944



**Broaching unit for ID and OD**

**TN765050** 414532003-55 1:1 EC

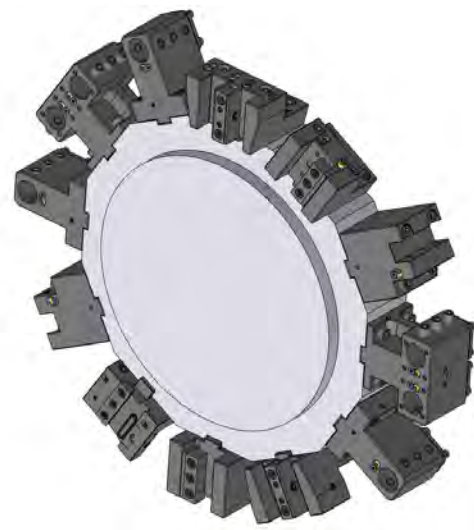
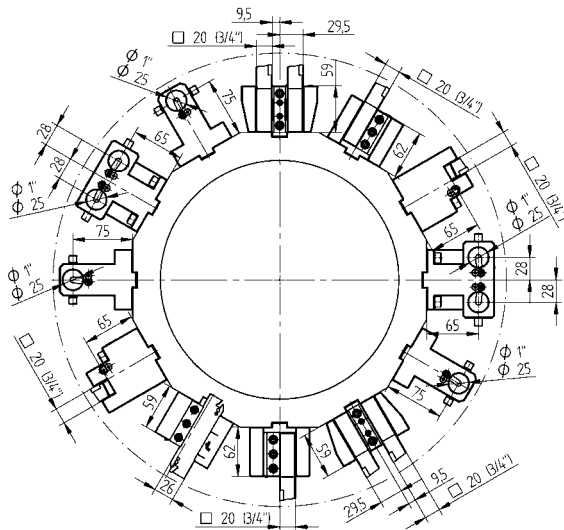

Static Toolholders - Standard Program

Static Toolholders - Enhanced Program



- OD cutting holder**  
 20 48-101470  
 Z90-86304-00  
 3/4" 48-104496
- OD cutting holder, HP-IC**  
 20 48-101470-HP IC 80 bar  
 3/4" 48-104496-HP IC 80 bar
- OD cutting holder, both sides**  
 20 48-101471  
 Z90-86303-00  
 3/4" 48-104755
- Face cutting holder**  
 20 48-102352  
 Z90-86301-00  
 3/4" 48-104735
- Combination toolholder, LF=75**  
 Ø 25 48-101472  
 Z90-86302-00  
 Ø 1" 48-104526



- OD cutting holder, double, Y axis**  
 20 48-101473  
 Z90-86548-00  
 3/4" 48-104523
- Cut-off holder**  
 SH 26 48-100419  
 Z90-86307-00
- Cut-off holder, HP-IC**  
 SH 26 48-102274R IC 80 bar  
 SH 26 48-102274L IC 80 bar  
 SH 32 48-112233R IC 80 bar  
 343-810100R95  
 SH 32 48-112233L IC 80 bar  
 343-810100L95
- Combination toolholder, universal, double, Y axis**  
 Ø 25 48-101474  
 Z90-86547-00  
 Ø 1" 48-104528



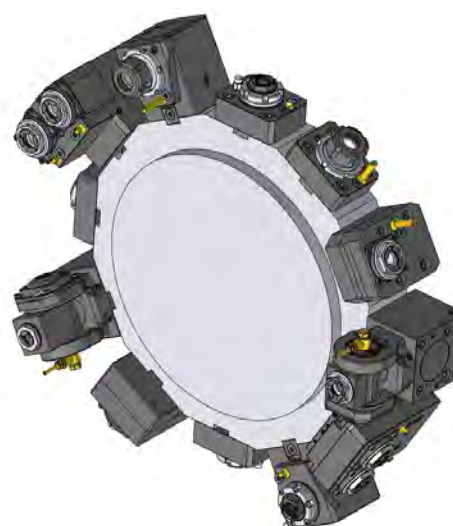
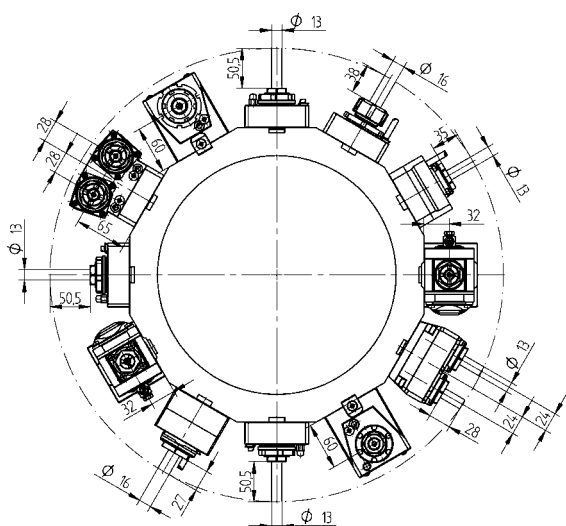

Driven Toolholders - QuickFlex®



**Straight drill/milling unit**

**ER-20 QF** 420120010-44 1:1 EC  
Z90-86300-00

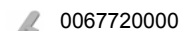

0067720000

**ER-20 QF** 420120011-44 1:1 IC 80 bar

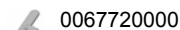

0067720000



**Right angle drill/milling unit, LF=60**

**ER-20 QF** 420520010-44 1:1 EC  
Z90-86299-00

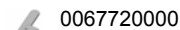

0067720000

**ER-20 QF** 420520011-44 1:1 IC 80 bar

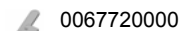

0067720000



**Right angle drill/milling unit, LF=75**

**ER-20 QF** 420520015-44 1:1 EC  
Z90-86300-00



0067720000

**ER-20 QF** 420520016-44 1:1 IC 80 bar

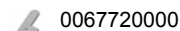

0067720000

Driven Toolholders - Enhanced Program



**Straight drill/milling unit**

**ER 25** 410116004-44 1:1 EC  
Z90-86305-00

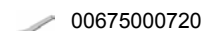

00675000720

**ER 25** 410116002-44 1:1 IC 80 bar

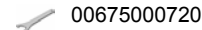

00675000720



**Straight offset drill/milling unit**

**ER 20** 410113004-44 1:2 EC  
Z90-89788-00

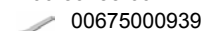

00675000939

**ER 16** 410110002-44 1:3 EC

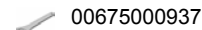

00675000937

**ER 25** 410116005-44 1.5:1 EC

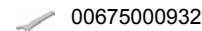

00675000932



**Right angle drill/milling unit, LF=60**

**ER 25** 410516005-44 1:1 EC  
Z90-86306-00

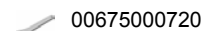

00675000720

**ER 25** 410516006-44 1:1 IC 80 bar

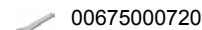

00675000720

**ER 20** 410513002-44 1:2 EC

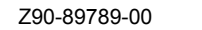

Z90-89789-00  
00675000833

**ER 20** 410513003-44 1:2 IC 80 bar

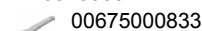

00675000833

**ER 16** 410810006-44 1:3 EC

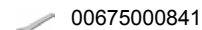

00675000841

**ER 16** 410810007-44 1:3 IC 80 bar

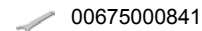

00675000841

**ER 25** 410516002-44 2:1 EC

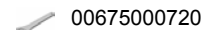

00675000720

**ER 25** 410516003-44 2:1 IC 80 bar

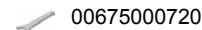

00675000720

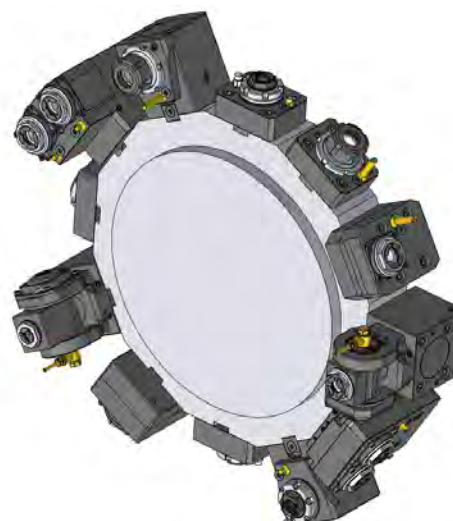
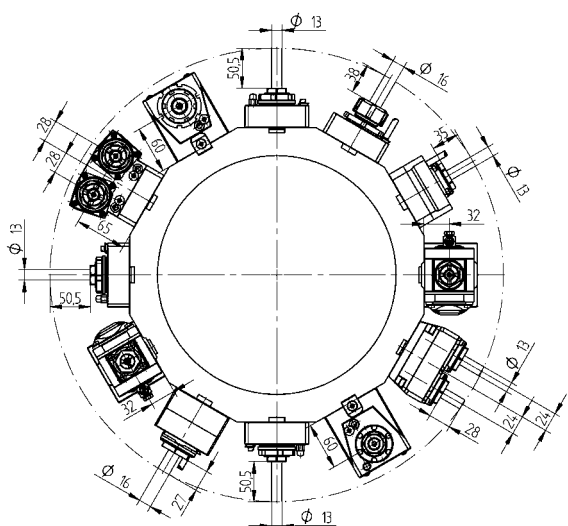

Driven Toolholders - Enhanced Program



**Right angle milling unit with combination mill arbor DIN 6358, LF=60**

<b>Ø 22</b>	410622000-44	1:1	EC
	00675000483		
<b>Ø 22</b>	410622001-44	2:1	EC
	00675000483		



**Adjustable angle drill/milling unit**

<b>ER 16</b>	411010004-44	1:1	EC
	Z90-89787-00		
	00675000902		
<b>ER 16</b>	411010005-44	1:1	IC 80 bar
	00675000902		
<b>ER 11</b>	411007006-44	1:2	EC
	00675000914		
<b>ER 11</b>	411007007-44	1:2	IC 80 bar
	00675000914		



**Straight drill/milling unit, double, Y axis**

<b>ER 20</b>	413002003-44	1:1	EC
	00675000939		
<b>ER 20</b>	413002004-44	1:1	IC 80 bar
	00675000939		



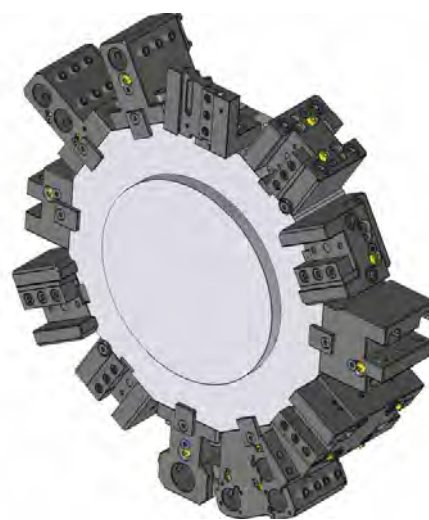
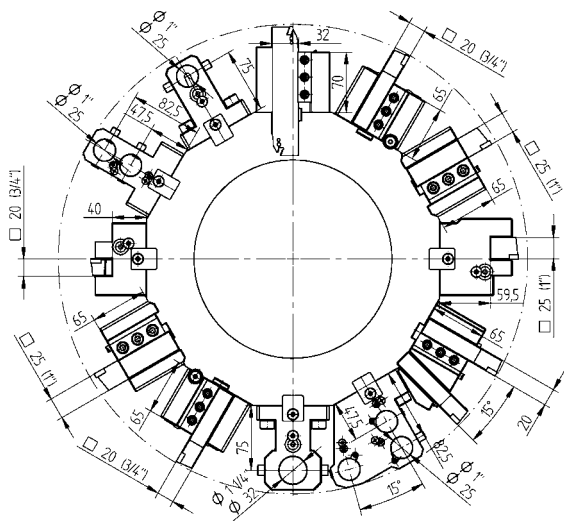

**2-spindle - Right angle drill/milling unit, Y axis**

<b>ER 20</b>	413502004-44	1:1	EC
	00675000939		
<b>ER 20</b>	413502005-44	1:1	IC 80 bar
	00675000939		





Static Toolholders - Standard Program

- 

**OD cutting holder**  
 20 48-108585  
 3/4" 48-108586  
 25 48-106720
- 

**OD cutting holder, HP-IC**  
 25 48-106720-HP IC 80 bar  
 1" 48-106730-HP IC 80 bar
- 

**OD cutting holder, both sides**  
 20 48-108460  
 3/4" 48-108588
- 

**Face cutting holder**  
 20 48-108590  
 3/4" 48-108591
- 

**Face cutting holder**  
 25 48-107758  
 1" 48-107759
- 

**Combination toolholder**  
 Ø 25 48-107842  
 Ø 1" 48-107879  
 Ø 32 48-106727  
 1 1/4" 48-106734

Static Toolholders - Enhanced Program

- 

**OD cutting holder, double, 24 station (only for turret size 340)**  
 20 48-108592 EC  
 3/4" 48-108593 EC
- 

**OD cutting holder, both sides, double, 24 station (only for turret size 340)**  
 20 48-108461 EC  
 3/4" 48-108595 EC
- 

**Cut-off holder**  
 SH 32 48-99637
- 

**Cut-off holder, HP-IC**  
 SH 32 48-102276R IC 80 bar  
 SH 32 48-102276L IC 80 bar
- 

**Cut-off holder, adjustable**  
 SH 32 48-110366 EC
- 

**Cut-off holder, adjustable, HP-IC**  
 SH 32 48-109656L IC 80 bar  
 343-810100L87  
 SH 32 48-109656R IC 80 bar  
 343-810100R87
- 

**Combination toolholder, double**  
 Ø 25 48-108596 IC 80 bar  
 Ø 1" 48-108597 IC 80 bar
- 

**Combination toolholder, universal, triple, 24 station (only for turret size 340)**  
 Ø 25 48-108462 IC 80 bar  
 Ø 1" 48-108599 IC 80 bar

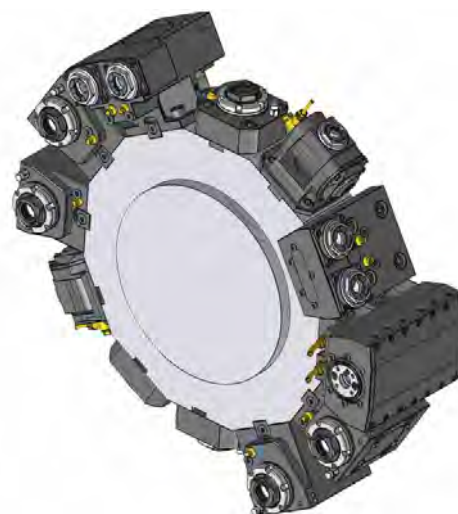
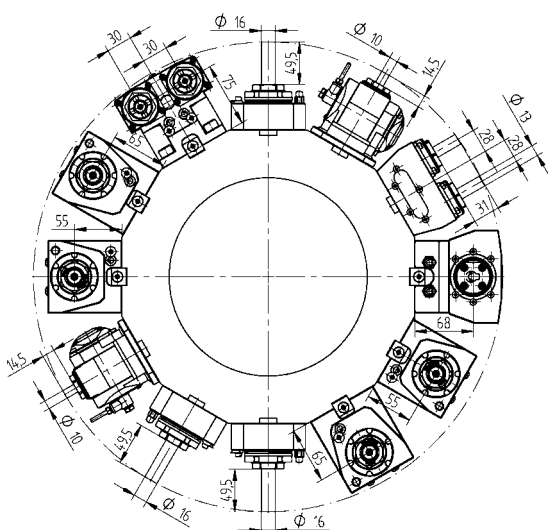

Driven Toolholders - QuickFlex®

	<b>Straight drill/milling unit</b>			
	<b>ER-25 QF</b>	420125022-55	1:1	EC
		0067725000		
	<b>ER-25 QF</b>	420125023-55	1:1	IC 80 bar
		0067725000		
	<b>Right angle drill/milling unit, LF=55</b>			
	<b>ER-25 QF</b>	420525087-55	1:1	EC
		0067725000		
	<b>ER-25 QF</b>	420525088-55	1:1	IC 80 bar
		0067725000		
	<b>Right angle drill/milling unit, LF=65</b>			
	<b>ER-25 QF</b>	420525085-55	1:1	EC
		0067725000		
	<b>ER-25 QF</b>	420525086-55	1:1	IC 80 bar
		0067725000		
	<b>Right angle drill/milling unit, both sides, LF=55</b>			
	<b>ER-25 QF</b>	420525069-55	1:1	EC
		0067725000		
	<b>Right angle drill/milling unit, both sides, LF=65</b>			
	<b>ER-25 QF</b>	420525077-55	1:1	EC
		0067725010		

Driven Toolholders - Enhanced Program

	<b>Straight drill/milling unit</b>			
	<b>ER 32</b>	410120002-55	1:1	EC
		0067825000		
	<b>ER 32</b>	410120003-55	1:1	IC 80 bar
		0067825000		
	<b>Straight milling unit</b>			
	<b>Ø 22</b>	410222002-55	1:1	EC
		00675000483		
	<b>Ø 3/4"</b>	410219000-55	1:1	EC
		00675000854		
	<b>Straight offset drill/milling unit</b>			
	<b>ER 25</b>	410116027-55	1:1	EC
		00675000932		
	<b>ER 25</b>	410116028-55	1:1	IC 80 bar
		00675000932		
	<b>ER 20</b>	410113006-55	1:2	EC
		00675000939		
	<b>ER 20</b>	410113004-55	1:2	IC 80 bar
		00675000939		
	<b>ER 16</b>	410410000-55	1:3	EC
		00675000937		
	<b>ER 16</b>	410410001-55	1:3	IC 80 bar
		00675000937		
	<b>ER 25</b>	410116021-55	2:1	EC
		00675000932		
	<b>ER 25</b>	410116022-55	2:1	IC 80 bar
		00675000932		



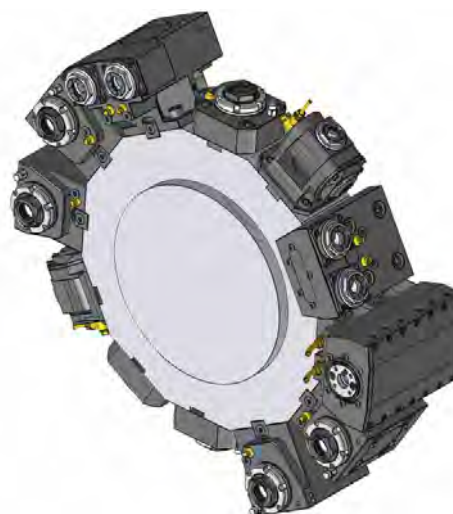
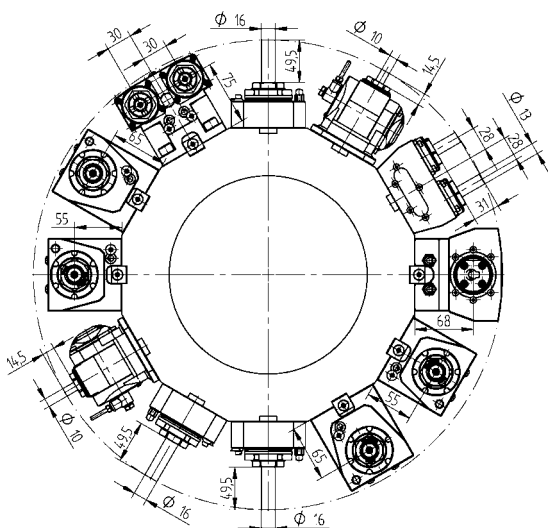

Driven Toolholders - Enhanced Program

Driven Toolholders - Enhanced Program



**Right angle drill/milling unit, LF=65**

<b>ER 32</b>	410520045-55	1:1	EC
	0067825000		
<b>ER 32</b>	410520046-55	1:1	IC 80 bar
	0067825000		
<b>ER-20 QF</b>	420520029-55	1:2	EC
	0067720001		
<b>ER-20 QF</b>	420520030-55	1:2	IC 80 bar
	0067720001		
<b>ER 16</b>	410810022-55	1:3	EC
	00675000841		
<b>ER 16</b>	410810023-55	1:3	IC 80 bar
	00675000841		
<b>ER-25 QF</b>	420525055-55	2:1	EC
	0067725000		
<b>ER-25 QF</b>	420525056-55	2:1	IC 80 bar
	0067725000		



**Right angle back set drill/milling unit, LF=65**

<b>ER 32</b>	410520007-55	1:1	EC
	00675000592		
<b>ER 32</b>	410520008-55	1:1	IC 80 bar
	00675000592		
<b>ER 32</b>	410520009-55	2:1	EC
	00675000592		
<b>ER 32</b>	410520010-55	2:1	IC 80 bar
	00675000592		



**Right angle milling unit with combination mill arbor DIN 6358, LF=65**

<b>Ø 22</b>	410622013-55	1:1	EC
	00675000483		
<b>Ø 22</b>	410622007-55	2:1	EC
	00675000483		
<b>Ø 3/4"</b>	410619008-55	1:1	EC
	00675000483		

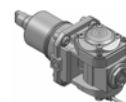

**Adjustable angle drill/milling unit**

<b>ER 16</b>	411010001-55	1:1	EC
	00675000902		
<b>ER 16</b>	411010002-55	1:1	IC 80 bar
	00675000902		
<b>ER 11</b>	411007003-55	1:2	EC
	00675000914		
<b>ER 11</b>	411007004-55	1:2	IC 80 bar
	00675000914		



**Straight drill/milling unit, double, Y axis**

<b>ER 20</b>	413002001-55	1:1	EC
	00675000944		



**2-spindle - Right angle drill/milling unit, Y axis**

<b>ER 20</b>	413502012-55	1:1	EC
	00675000944		



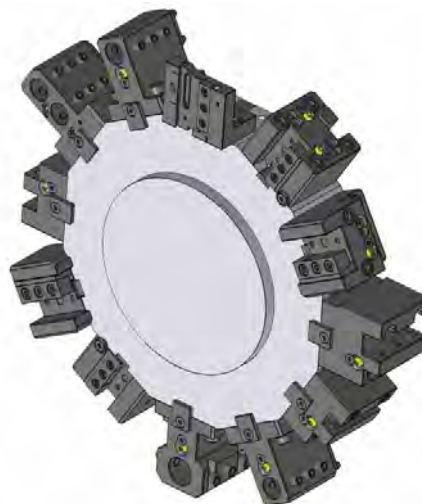
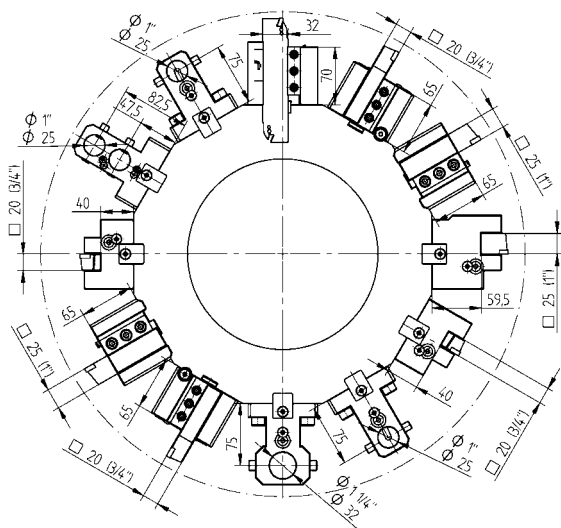

**Broaching unit for ID and OD**

<b>TN765050</b>	414532003-55	1:1	EC
-----------------	--------------	-----	----





Static Toolholders - Standard Program

- 

**OD cutting holder**  
 20 48-108585  
 3/4" 48-108586  
 25 48-106720
- 

**OD cutting holder, HP-IC**  
 25 48-106720-HP IC 80 bar  
 1" 48-106730-HP IC 80 bar
- 

**OD cutting holder, both sides**  
 20 48-108460  
 3/4" 48-108588
- 

**Face cutting holder**  
 20 48-108590  
 3/4" 48-108591
- 

**Face cutting holder**  
 25 48-107758  
 1" 48-107759
- 

**Combination toolholder**  
 Ø 25 48-107842  
 Ø 1" 48-107879  
 Ø 32 48-106727  
 1 1/4" 48-106734

Static Toolholders - Enhanced Program

- 

**Cut-off holder**  
 SH 32 48-99637
- 

**Cut-off holder, HP-IC**  
 SH 32 48-102276R IC 80 bar  
 SH 32 48-102276L IC 80 bar
- 

**Cut-off holder, adjustable**  
 SH 32 48-110366 EC
- 

**Cut-off holder, adjustable, HP-IC**  
 SH 32 48-109656L IC 80 bar  
 343-810100L87  
 SH 32 48-109656R IC 80 bar  
 343-810100R87
- 

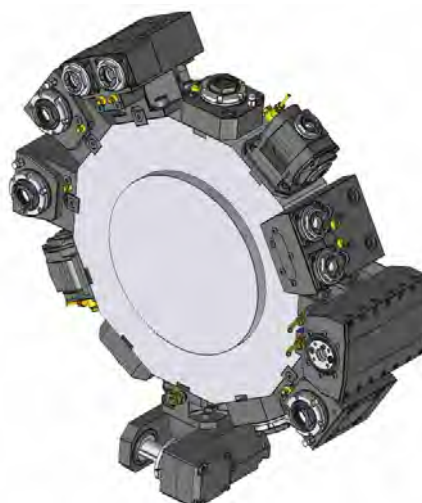
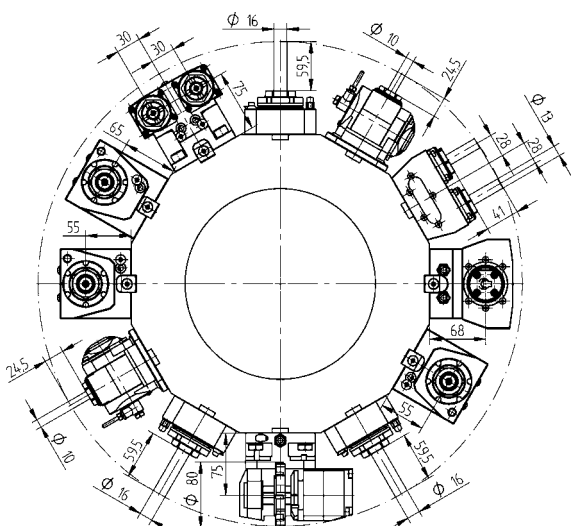

**Combination toolholder, double**  
 Ø 25 48-108596 IC 80 bar  
 Ø 1" 48-108597 IC 80 bar





Driven Toolholders - QuickFlex®

- 



**Straight drill/milling unit**

<b>ER-25 QF</b>	420125022-55	1:1	EC
	 0067725000		
<b>ER-25 QF</b>	420125023-55	1:1	IC 80 bar
	 0067725000		
- 



**Right angle drill/milling unit, LF=55**

<b>ER-25 QF</b>	420525087-55	1:1	EC
	 0067725000		
<b>ER-25 QF</b>	420525088-55	1:1	IC 80 bar
	 0067725000		
- 

**Right angle drill/milling unit, LF=65**

<b>ER-25 QF</b>	420525085-55	1:1	EC
	 0067725000		
<b>ER-25 QF</b>	420525086-55	1:1	IC 80 bar
	 0067725000		
- 

**Right angle drill/milling unit, both sides, LF=55**

<b>ER-25 QF</b>	420525069-55	1:1	EC
	 0067725000		
- 



**Right angle drill/milling unit, both sides, LF=65**

<b>ER-25 QF</b>	420525077-55	1:1	EC
	 0067725010		



Driven Toolholders - Enhanced Program

- 









**Straight drill/milling unit**

<b>ER 32</b>	410120002-55	1:1	EC
	 0067825000		
<b>ER 32</b>	410120003-55	1:1	IC 80 bar
	 0067825000		
- 

**Straight milling unit**

<b>Ø 22</b>	410222002-55	1:1	EC
	 00675000483		
<b>Ø 3/4"</b>	410219000-55	1:1	EC
	 00675000854		
- 

**Straight offset drill/milling unit**

<b>ER 25</b>	410116027-55	1:1	EC
	 00675000932		
<b>ER 25</b>	410116028-55	1:1	IC 80 bar
	 00675000932		
<b>ER 20</b>	410113006-55	1:2	EC
	 00675000939		
<b>ER 20</b>	410113004-55	1:2	IC 80 bar
	 00675000939		
<b>ER 16</b>	410410000-55	1:3	EC
	 00675000937		
<b>ER 16</b>	410410001-55	1:3	IC 80 bar
	 00675000937		
<b>ER 25</b>	410116021-55	2:1	EC
	 00675000932		
<b>ER 25</b>	410116022-55	2:1	IC 80 bar
	 00675000932		

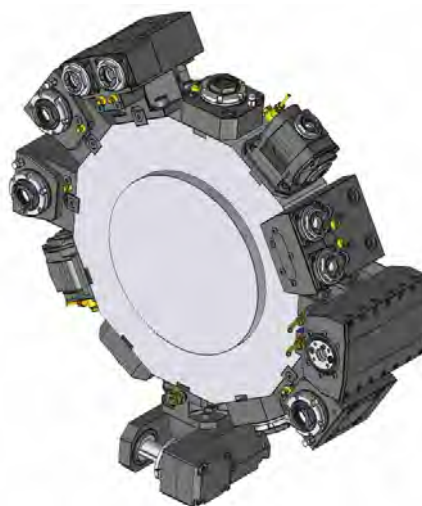
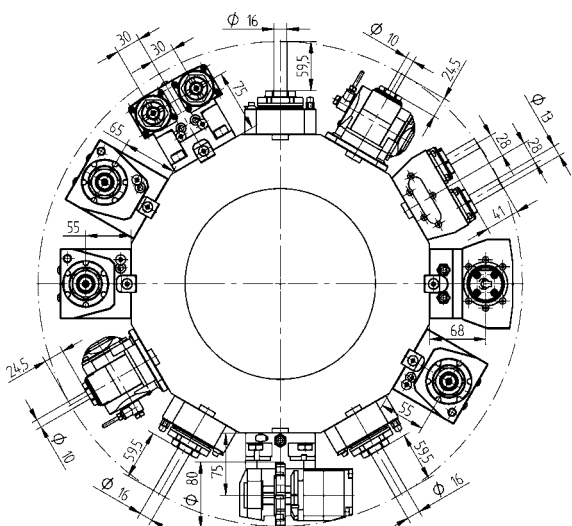

Driven Toolholders - Enhanced Program

Driven Toolholders - Enhanced Program



**Right angle drill/milling unit, LF=65**

<b>ER 32</b>	410520045-55	1:1	EC
	0067825000		
<b>ER 32</b>	410520046-55	1:1	IC 80 bar
	0067825000		
<b>ER-20 QF</b>	420520029-55	1:2	EC
	0067720001		
<b>ER-20 QF</b>	420520030-55	1:2	IC 80 bar
	0067720001		
<b>ER 16</b>	410810022-55	1:3	EC
	00675000841		
<b>ER 16</b>	410810023-55	1:3	IC 80 bar
	00675000841		
<b>ER-25 QF</b>	420525055-55	2:1	EC
	0067725000		
<b>ER-25 QF</b>	420525056-55	2:1	IC 80 bar
	0067725000		



**Right angle back set drill/milling unit, LF=65**

<b>ER 32</b>	410520007-55	1:1	EC
	00675000592		
<b>ER 32</b>	410520008-55	1:1	IC 80 bar
	00675000592		
<b>ER 32</b>	410520009-55	2:1	EC
	00675000592		
<b>ER 32</b>	410520010-55	2:1	IC 80 bar
	00675000592		



**Right angle milling unit with combination mill arbor DIN 6358, LF=65**

<b>Ø 22</b>	410622013-55	1:1	EC
	00675000483		
<b>Ø 22</b>	410622007-55	2:1	EC
	00675000483		
<b>Ø 3/4"</b>	410619008-55	1:1	EC
	00675000483		

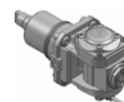

**Adjustable angle drill/milling unit**

<b>ER 16</b>	411010001-55	1:1	EC
	00675000902		
<b>ER 16</b>	411010002-55	1:1	IC 80 bar
	00675000902		
<b>ER 11</b>	411007003-55	1:2	EC
	00675000914		
<b>ER 11</b>	411007004-55	1:2	IC 80 bar
	00675000914		



**Slitting saw unit**

<b>Type 14-2</b>	411500000-55	2.73:1	EC
	00675000489		
	160016142 Ø 16		
	160022142 Ø 22		
	160027142 Ø 27		
	160015142 Ø 5/8"		
	160019142 Ø 3/4"		
	160023142 Ø 7/8"		
	160025142 Ø 1"		



**Straight drill/milling unit, double, Y axis**

<b>ER 20</b>	413002001-55	1:1	EC
	00675000944		



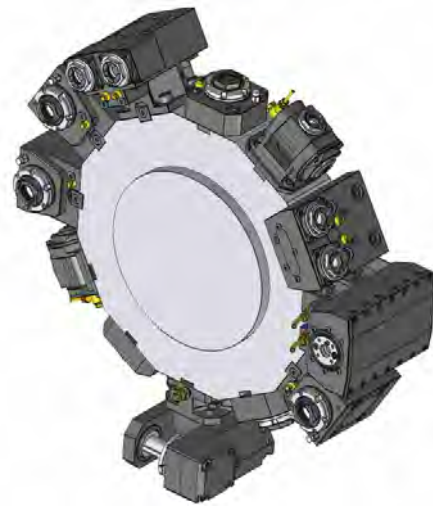
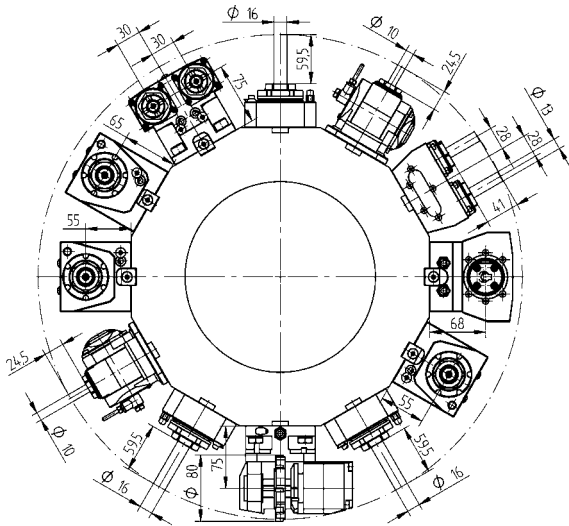

Driven Toolholders - Enhanced Program



**2-spindle - Right angle drill/milling unit, Y axis**

**ER 20**    413502012-55    1:1    EC  
 00675000944



**Broaching unit for ID and OD**

**TN765050** 414532003-55    1:1    EC

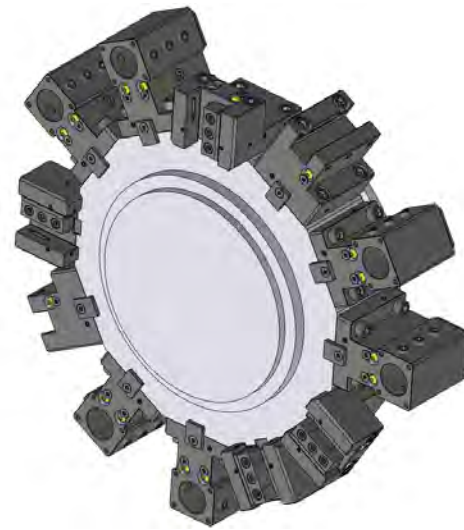
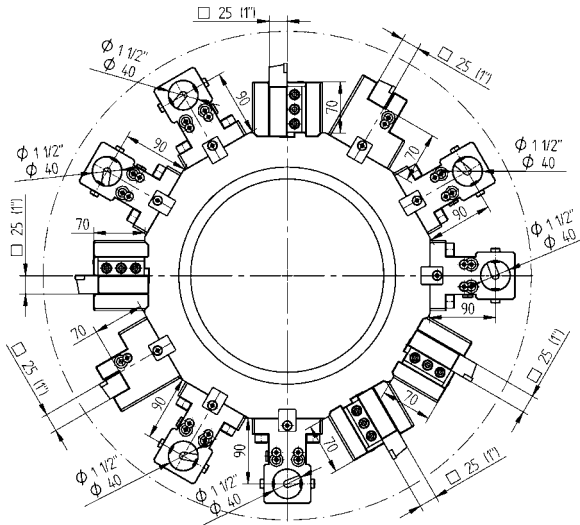

Static Toolholders - Standard Program

Static Toolholders - Enhanced Program



**OD cutting holder, HP-IC**

- 25**      48-107657-HP    IC 80 bar
- 1"**      48-107658-HP    IC 80 bar



**Face cutting holder, HP-IC**

- 25**      48-113236-HP    IC 80 bar
- 1"**      48-113237-HP    IC 80 bar



**Combination toolholder**

- Ø 40**      48-107659
  - 241140020 ER32
  - 241140026 ER40
- Ø 1 1/2"**    48-107660
  - 2411150020 ER32



**Cut-off holder**

- SH 32**    48-100204



**Cut-off holder, HP-IC**

- SH 32**    48-102279R      IC 80 bar
- SH 32**    48-102279L      IC 80 bar

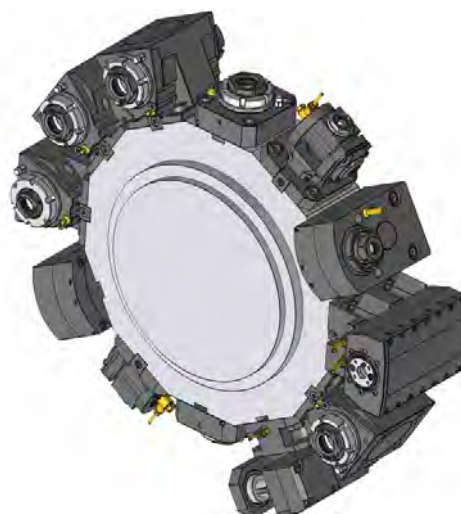
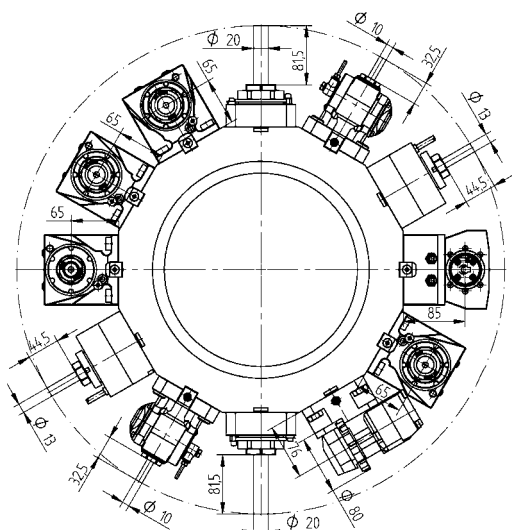



Driven Toolholders - QuickFlex®



Driven Toolholders - Enhanced Program

- 

**Straight drill/milling unit**

<b>ER-32 QF</b>	420132019-65	1:1	EC
	 0067732000		
<b>ER-32 QF</b>	420132020-65	1:1	IC 80 bar
	 0067732000		
- 

**Right angle drill/milling unit**





<b>ER-32 QF</b>	420532025-65	1:1	EC
	 0067732000		
<b>ER-32 QF</b>	420532026-65	1:1	IC 80 bar
	 0067732000		
- 

**Right angle drill/milling unit, both sides**





<b>ER-32 QF</b>	420532043-65	1:1	EC
	 0067732000		

- 





**Straight offset drill/milling unit**

<b>ER 32</b>	410120030-65	1:1	EC
	 00675000958		
<b>ER 32</b>	410120031-65	1:1	IC 80 bar
	 00675000958		
<b>ER 20</b>	410113002-65	1:2	EC
	 00675000591		
<b>ER 20</b>	410113003-65	1:2	IC 80 bar
	 00675000591		
- 

**Right angle drill/milling unit**

<b>ER-25 QF</b>	420525014-65	1:2	EC
	 0067725001		
<b>ER-25 QF</b>	420525015-65	1:2	IC 80 bar
	 0067725001		
<b>ER-32 QF</b>	420532031-65	2:1	EC
	 0067732000		
<b>ER-32 QF</b>	420532032-65	2:1	IC 80 bar
	 0067732000		
- 

**Adjustable angle drill/milling unit**

<b>ER 16</b>	411010000-65	1:1	EC
	 00675000902		
<b>ER 16</b>	411010001-65	1:1	IC 80 bar
	 00675000902		
<b>ER 11</b>	411007001-65	1:2	EC
	 00675000914		
<b>ER 11</b>	411007000-65	1:2	IC 80 bar
	 00675000914		

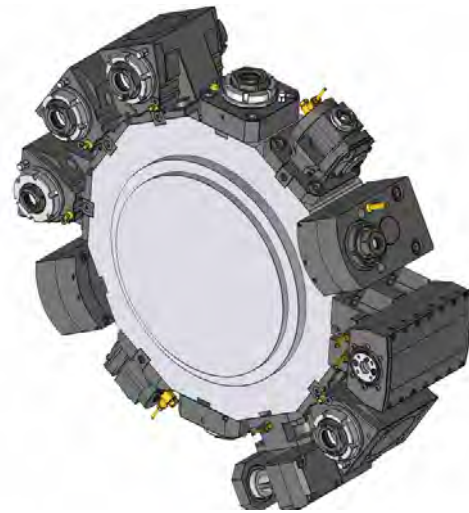
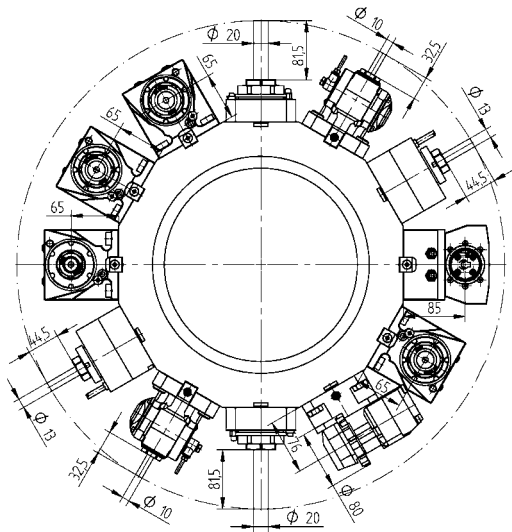

Driven Toolholders - Enhanced Program





**Offset slitting saw unit**

**Type 14-2** 411500001-65 2.73:1 EC

00675000448

 160016142 Ø 16

 160022142 Ø 22

 160027142 Ø 27

 160015142 Ø 5/8"

 160019142 Ø 3/4"

 160023142 Ø 7/8"

 160025142 Ø 1"



**Broaching unit for ID and OD**

**TN765050** 414532003-65 1:1 EC



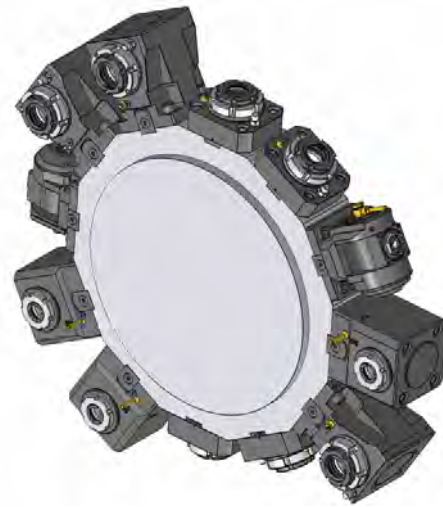
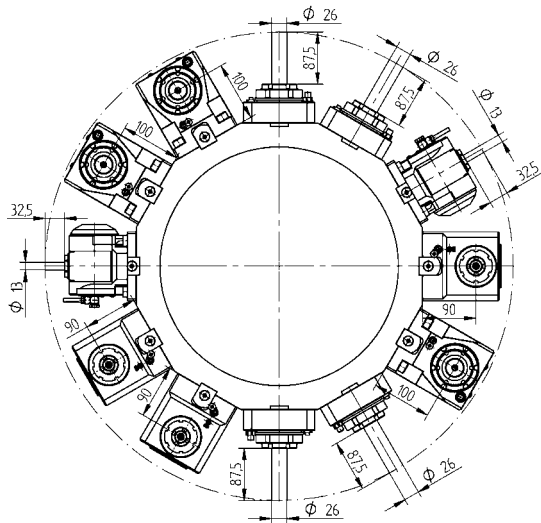

Driven Toolholders - QuickFlex®



**Straight drill/milling unit**

**ER-40 QF** 420140010-75 1:1 EC  
 0067740000

**ER-40 QF** 420140011-75 1:1 IC 80 bar  
 0067740000



**Right angle drill/milling unit**

**ER-40 QF** 420540010-75 1:1 EC  
 0067740000

**ER-40 QF** 420540011-75 1:1 IC 80 bar  
 0067740000

Driven Toolholders - Enhanced Program



**Right angle drill/milling unit**

**ER 25** 410516000-75 1:2 EC  
 00675000897

**ER 25** 410516001-75 1:2 IC 80 bar  
 00675000897



**Adjustable angle drill/milling unit**

**ER 20** 411013000-75 1:1 EC  
 00675000928





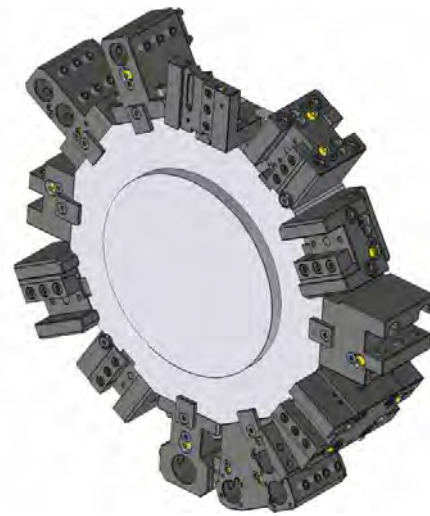
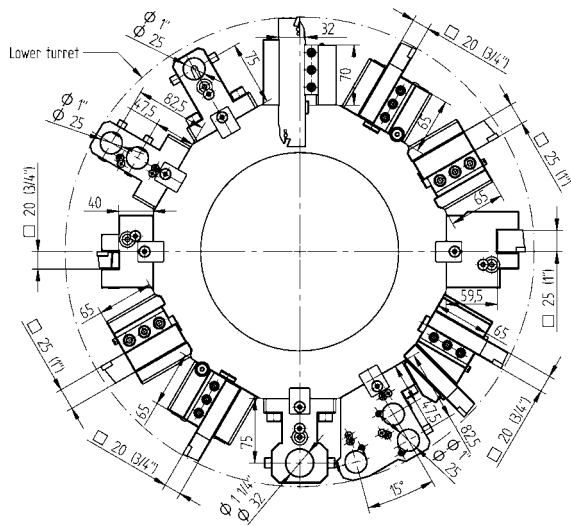

**ER 20** 411013001-75 1:1 IC 80 bar  
 00675000928

**ER 16** 411010000-75 1:2 EC  
 00675000936









**ER 16** 411010001-75 1:2 IC 80 bar  
 00675000936



Static Toolholders - Standard Program

	<b>OD cutting holder</b>		
	20	48-108585	
	3/4"	48-108586	
	25	48-106720	
	<b>OD cutting holder, HP-IC</b>		
	25	48-106720-HP	IC 80 bar
	1"	48-106730-HP	IC 80 bar
	<b>OD cutting holder, both sides</b>		
	20	48-108460	
	3/4"	48-108588	
	<b>Face cutting holder</b>		
	20	48-108590	
	3/4"	48-108591	
	<b>Face cutting holder</b>		
	25	48-107758	
	1"	48-107759	
	<b>Combination toolholder</b>		
	Ø 25	48-107842	
	Ø 1"	48-107879	
	Ø 32	48-106727	
	1 1/4"	48-106734	

Static Toolholders - Enhanced Program

	<b>OD cutting holder, double, 24 station (only for turret size 340)</b>		
	20	48-108592	EC
	3/4"	48-108593	EC
	<b>OD cutting holder, both sides, double, 24 station (only for turret size 340)</b>		
	20	48-108461	EC
	3/4"	48-108595	EC
	<b>Cut-off holder</b>		
	SH 32	48-99637	
	<b>Cut-off holder, HP-IC</b>		
	SH 32	48-102276R	IC 80 bar
	SH 32	48-102276L	IC 80 bar
	<b>Cut-off holder, adjustable</b>		
	SH 32	48-110366	EC
	<b>Cut-off holder, adjustable, HP-IC</b>		
	SH 32	48-109656L	IC 80 bar
		343-810100L87	
	SH 32	48-109656R	IC 80 bar
		343-810100R87	
	<b>Combination toolholder, double</b>		
	Ø 25	48-108596	IC 80 bar
	Ø 1"	48-108597	IC 80 bar
	<b>Combination toolholder, universal, triple, 24 station (only for turret size 340)</b>		
	Ø 25	48-108462	IC 80 bar
	Ø 1"	48-108599	IC 80 bar

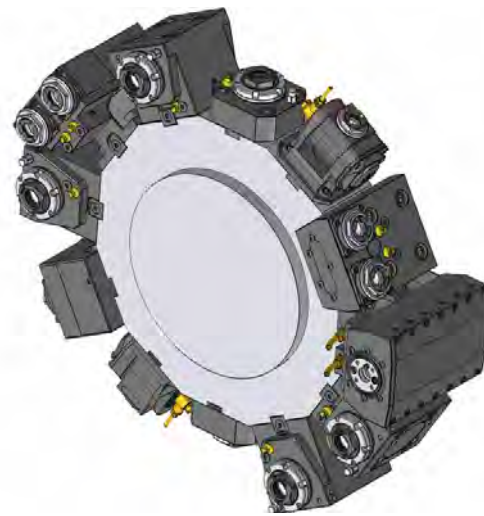
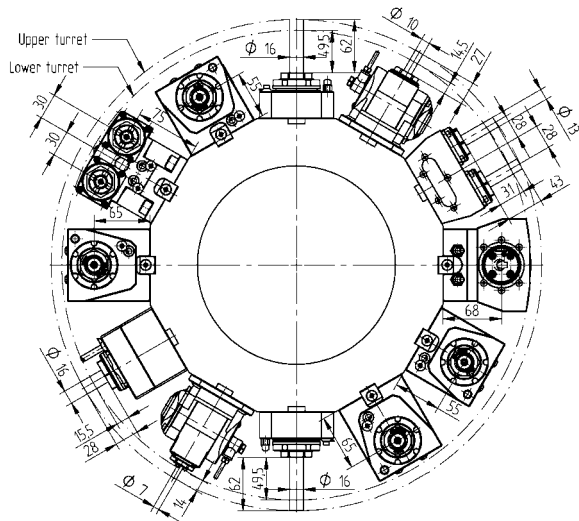

Driven Toolholders - QuickFlex®



**Straight drill/milling unit**

**ER-25 QF** 420125022-55 1:1 EC  
 0067725000

**ER-25 QF** 420125023-55 1:1 IC 80 bar  
 0067725000



**Right angle drill/milling unit, LF=55**

**ER-25 QF** 420525087-55 1:1 EC  
 0067725000

**ER-25 QF** 420525088-55 1:1 IC 80 bar  
 0067725000



**Right angle drill/milling unit, LF=65**

**ER-25 QF** 420525085-55 1:1 EC  
 0067725000

**ER-25 QF** 420525086-55 1:1 IC 80 bar  
 0067725000



**Right angle drill/milling unit, both sides, LF=55**

**ER-25 QF** 420525069-55 1:1 EC  
 0067725000



**Right angle drill/milling unit, both sides, LF=65**

**ER-25 QF** 420525077-55 1:1 EC  
 0067725010

Driven Toolholders - Enhanced Program



**Straight drill/milling unit**

**ER 32** 410120002-55 1:1 EC  
 0067825000

**ER 32** 410120003-55 1:1 IC 80 bar  
 0067825000



**Straight milling unit**

**Ø 22** 410222002-55 1:1 EC  
 00675000483

**Ø 3/4"** 410219000-55 1:1 EC  
 00675000854



**Straight offset drill/milling unit**

**ER 25** 410116027-55 1:1 EC  
 00675000932

**ER 25** 410116028-55 1:1 IC 80 bar  
 00675000932

**ER 20** 410113006-55 1:2 EC  
 00675000939

**ER 20** 410113004-55 1:2 IC 80 bar  
 00675000939

**ER 16** 410410000-55 1:3 EC  
 00675000937

**ER 16** 410410001-55 1:3 IC 80 bar  
 00675000937

**ER 25** 410116021-55 2:1 EC  
 00675000932

**ER 25** 410116022-55 2:1 IC 80 bar  
 00675000932

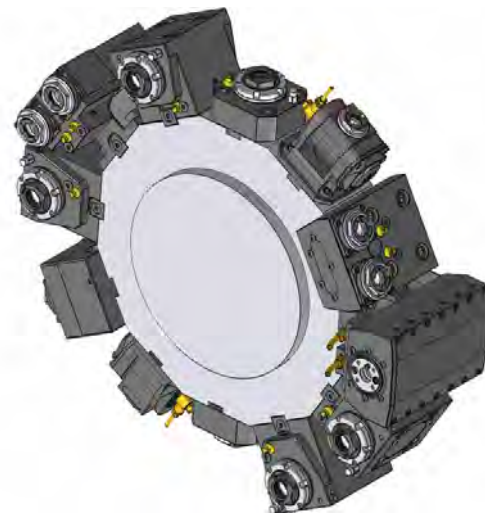
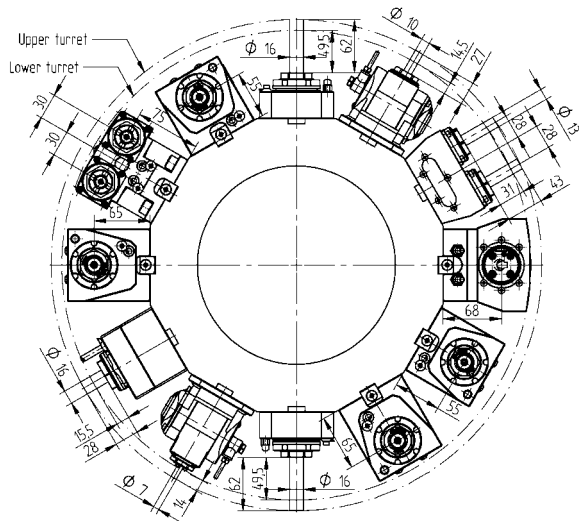

Driven Toolholders - Enhanced Program



**Right angle drill/milling unit, LF=65**

<b>ER 32</b>	410520045-55	1:1	EC
	0067825000		
<b>ER 32</b>	410520046-55	1:1	IC 80 bar
	0067825000		
<b>ER-20 QF</b>	420520029-55	1:2	EC
	0067720001		
<b>ER-20 QF</b>	420520030-55	1:2	IC 80 bar
	0067720001		
<b>ER 16</b>	410810022-55	1:3	EC
	00675000841		
<b>ER 16</b>	410810023-55	1:3	IC 80 bar
	00675000841		
<b>ER-25 QF</b>	420525055-55	2:1	EC
	0067725000		
<b>ER-25 QF</b>	420525056-55	2:1	IC 80 bar
	0067725000		



**Right angle milling unit with combination mill arbor DIN 6358, LF=65**

<b>Ø 22</b>	410622013-55	1:1	EC
	00675000483		
<b>Ø 22</b>	410622007-55	2:1	EC
	00675000483		
<b>Ø 3/4"</b>	410619008-55	1:1	EC
	00675000483		

Driven Toolholders - Enhanced Program



**Right angle back set drill/milling unit, LF=65**

<b>ER 32</b>	410520007-55	1:1	EC
	00675000592		
<b>ER 32</b>	410520008-55	1:1	IC 80 bar
	00675000592		
<b>ER 32</b>	410520009-55	2:1	EC
	00675000592		
<b>ER 32</b>	410520010-55	2:1	IC 80 bar
	00675000592		



**Adjustable angle drill/milling unit**

<b>ER 16</b>	411010001-55	1:1	EC
	00675000902		
<b>ER 16</b>	411010002-55	1:1	IC 80 bar
	00675000902		
<b>ER 11</b>	411007003-55	1:2	EC
	00675000914		
<b>ER 11</b>	411007004-55	1:2	IC 80 bar
	00675000914		



**Straight drill/milling unit, double, Y axis**

<b>ER 20</b>	413002001-55	1:1	EC
	00675000944		



**2-spindle - Right angle drill/milling unit, Y axis**

<b>ER 20</b>	413502012-55	1:1	EC
	00675000944		



**Broaching unit for ID and OD**

<b>TN765050</b>	414532003-55	1:1	EC
-----------------	--------------	-----	----



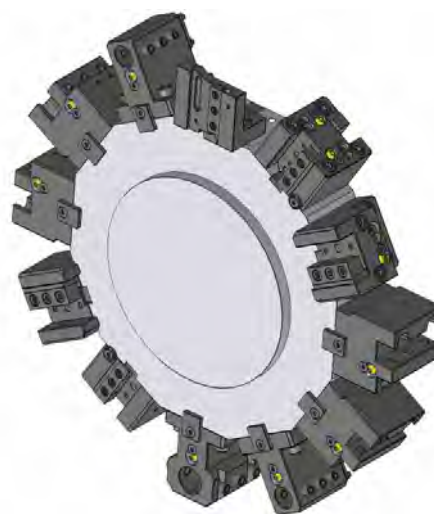
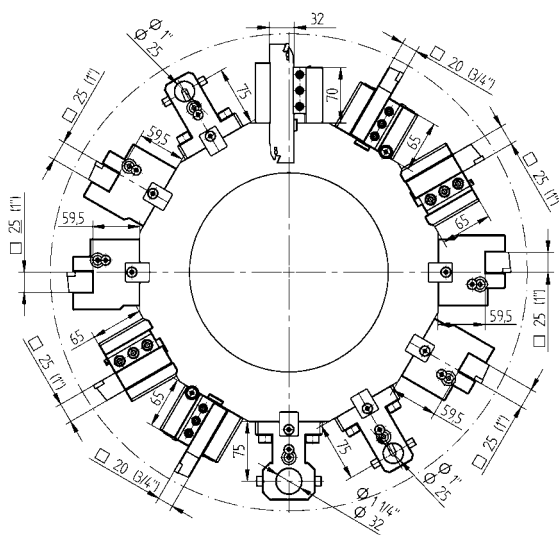



Static Toolholders - Standard Program

- 

**OD cutting holder**  
 20 48-108585  
 3/4" 48-108586  
 25 48-106720
- 

**OD cutting holder, HP-IC**  
 25 48-106720-HP IC 80 bar  
 1" 48-106730-HP IC 80 bar
- 

**OD cutting holder, both sides**  
 20 48-108460  
 3/4" 48-108588
- 

**Face cutting holder**  
 25 48-107758  
 1" 48-107759
- 

**Combination toolholder**  
 Ø 25 48-107842  
 Ø 1" 48-107879  
 Ø 32 48-106727  
 1 1/4" 48-106734

Static Toolholders - Enhanced Program

- 

**Cut-off holder**  
 SH 32 48-99637
- 

**Cut-off holder, HP-IC**  
 SH 32 48-102276R IC 80 bar  
 SH 32 48-102276L IC 80 bar
- 

**Cut-off holder, adjustable**  
 SH 32 48-110366 EC
- 

**Cut-off holder, adjustable, HP-IC**  
 SH 32 48-109656L IC 80 bar  
 343-810100L87  
 SH 32 48-109656R IC 80 bar  
 343-810100R87

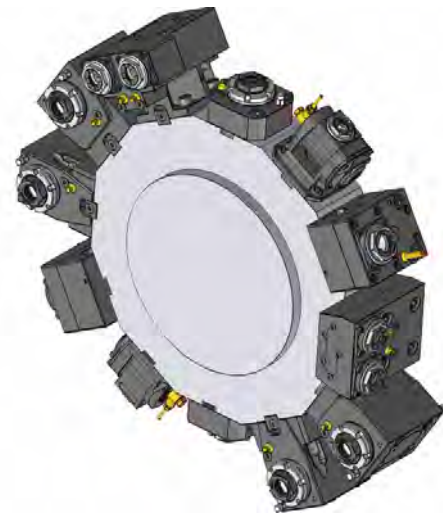
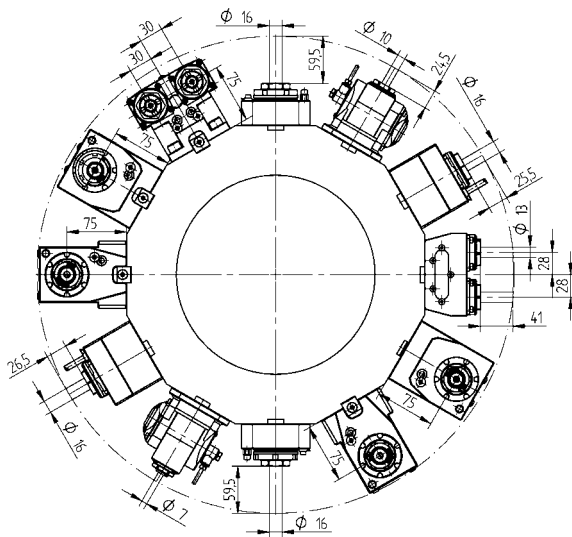

Driven Toolholders - QuickFlex®



**Straight drill/milling unit**

**ER-25 QF** 420125022-55 1:1 EC  
 0067725000

**ER-25 QF** 420125023-55 1:1 IC 80 bar  
 0067725000



**Right angle drill/milling unit, LF=75**

**ER-25 QF** 420525078-55 1:1 EC  
 0067725000

**ER-25 QF** 420525079-55 1:1 IC 80 bar  
 0067725000



**Right angle drill/milling unit, both sides, LF=75**

**ER-25 QF** 420525080-55 1:1 EC  
 0067725000

Driven Toolholders - Enhanced Program



**Straight drill/milling unit**

**ER 32** 410120002-55 1:1 EC  
 0067825000

**ER 32** 410120003-55 1:1 IC 80 bar  
 0067825000



**Straight milling unit**

**Ø 22** 410222002-55 1:1 EC  
 00675000483

**Ø 3/4"** 410219000-55 1:1 EC  
 00675000854



**Straight offset drill/milling unit**

**ER 25** 410116027-55 1:1 EC  
 00675000932

**ER 25** 410116028-55 1:1 IC 80 bar  
 00675000932

**ER 20** 410113006-55 1:2 EC  
 00675000939

**ER 20** 410113004-55 1:2 IC 80 bar  
 00675000939

**ER 16** 410410000-55 1:3 EC  
 00675000937

**ER 16** 410410001-55 1:3 IC 80 bar  
 00675000937

**ER 25** 410116021-55 2:1 EC  
 00675000932

**ER 25** 410116022-55 2:1 IC 80 bar  
 00675000932

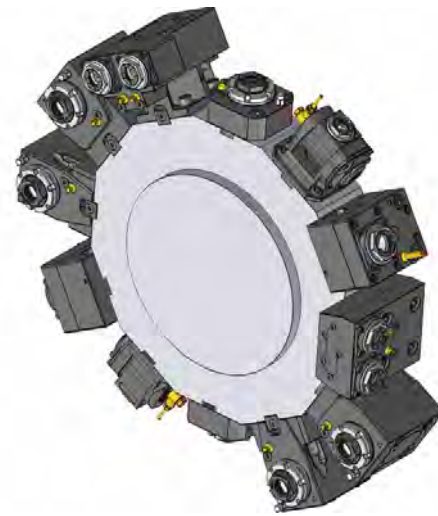
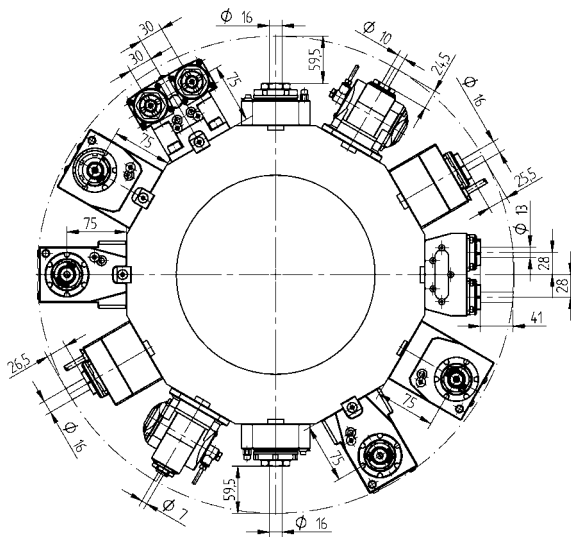

Driven Toolholders - Enhanced Program

Driven Toolholders - Enhanced Program



Right angle drill/milling unit, LF=75				
ER 32	410520021-55	1:1	EC	
	00675000592			
ER 32	410520011-55	1:1	IC 80 bar	
	00675000592			
ER-20 QF	420520027-55	1:2	EC	
	0067720001			
ER-20 QF	420520028-55	1:2	IC 80 bar	
	0067720001			
ER 16	410810024-55	1:3	EC	
	00675000841			
ER 16	410810025-55	1:3	IC 80 bar	
	00675000841			
ER 32	410520022-55	2:1	EC	
	00675000592			
ER 32	410520023-55	2:1	IC 80 bar	
	00675000592			



Slitting saw unit			
Type 14-2	411500000-55	2.73:1	EC
	00675000489		
	160016142 Ø 16		
	160022142 Ø 22		
	160027142 Ø 27		
	160015142 Ø 5/8"		
	160019142 Ø 3/4"		
	160023142 Ø 7/8"		
	160025142 Ø 1"		



Right angle milling unit with combination mill arbor DIN 6358, LF=75				
Ø 22	410622014-55	1:1	EC	
	00675000483			
Ø 22	410622008-55	2:1	EC	
	00675000483			
Ø 3/4"	410619009-55	1:1	EC	
	00675000483			



Straight drill/milling unit, double, Y axis			
ER 20	413002001-55	1:1	EC
	00675000944		



2-spindle - Right angle drill/milling unit, Y axis			
ER 20	413502012-55	1:1	EC
	00675000944		



Adjustable angle drill/milling unit				
ER 16	411010001-55	1:1	EC	
	00675000902			
ER 16	411010002-55	1:1	IC 80 bar	
	00675000902			
ER 11	411007003-55	1:2	EC	
	00675000914			
ER 11	411007004-55	1:2	IC 80 bar	
	00675000914			

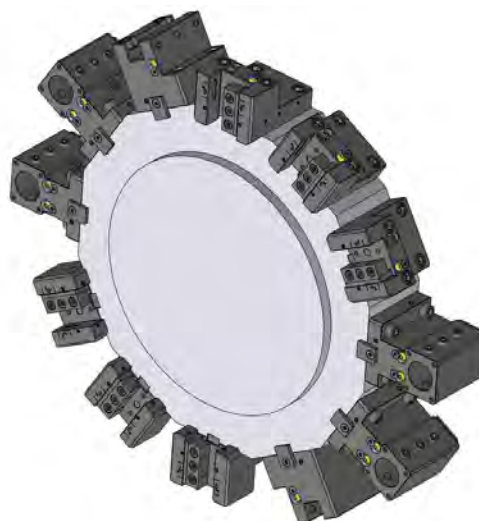
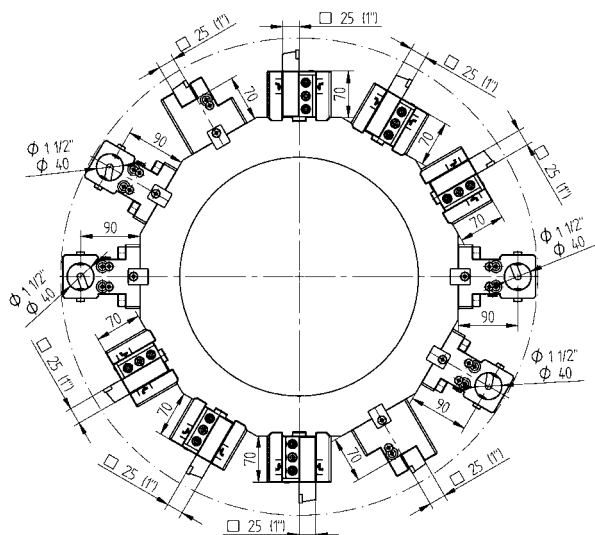

Static Toolholders - Standard Program

Static Toolholders - Enhanced Program

- 



**OD cutting holder, HP-IC**

<b>25</b>	48-107657-HP	IC 80 bar
<b>1"</b>	48-107658-HP	IC 80 bar
  
- 

**Face cutting holder, HP-IC**

<b>25</b>	48-113236-HP	IC 80 bar
<b>1"</b>	48-113237-HP	IC 80 bar
  
- 

**Combination toolholder**

<b>Ø 40</b>	48-107659	
	 241140020 ER32	
	 241140026 ER40	
<b>Ø 1 1/2"</b>	48-107660	
	 2411150020 ER32	

- 

**Cut-off holder**

<b>SH 32</b>	48-100204	
--------------	-----------	--
  
- 

**Cut-off holder, HP-IC**

<b>SH 32</b>	48-102279R	IC 80 bar
<b>SH 32</b>	48-102279L	IC 80 bar



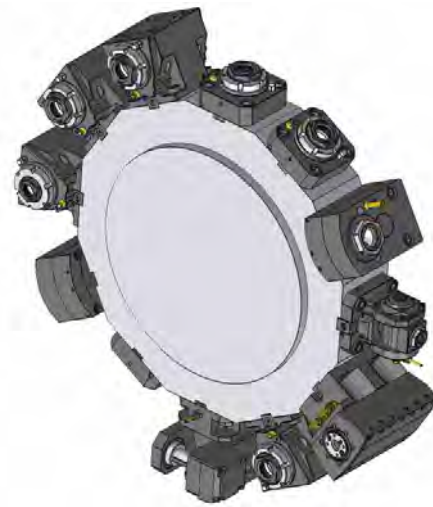
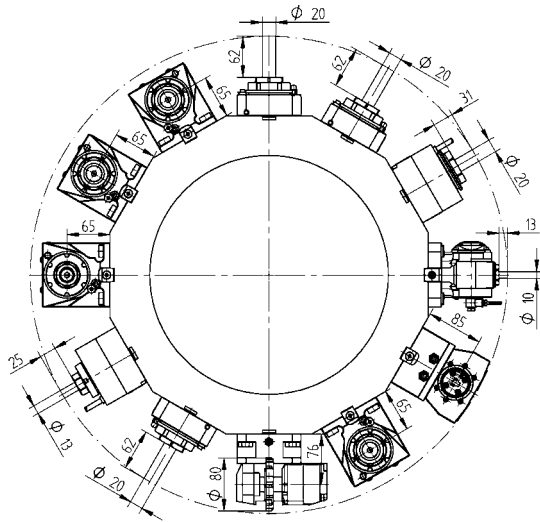

Driven Toolholders - QuickFlex®

Driven Toolholders - Enhanced Program



**Straight drill/milling unit**

- ER-32 QF** 420132019-65 1:1 EC  
0067732000
- ER-32 QF** 420132020-65 1:1 IC 80 bar  
0067732000



**Right angle drill/milling unit**

- ER-32 QF** 420532025-65 1:1 EC  
0067732000
- ER-32 QF** 420532026-65 1:1 IC 80 bar  
0067732000



**Right angle drill/milling unit, both sides**

- ER-32 QF** 420532043-65 1:1 EC  
0067732000



**Straight offset drill/milling unit**

- ER 32** 410120030-65 1:1 EC  
00675000958
- ER 32** 410120031-65 1:1 IC 80 bar  
00675000958
- ER 20** 410113002-65 1:2 EC  
00675000591
- ER 20** 410113003-65 1:2 IC 80 bar  
00675000591



**Right angle drill/milling unit**

- ER-25 QF** 420525014-65 1:2 EC  
0067725001
- ER-25 QF** 420525015-65 1:2 IC 80 bar  
0067725001
- ER-32 QF** 420532031-65 2:1 EC  
0067732000
- ER-32 QF** 420532032-65 2:1 IC 80 bar  
0067732000



**Adjustable angle drill/milling unit**

- ER 16** 411010000-65 1:1 EC  
00675000902
- ER 16** 411010001-65 1:1 IC 80 bar  
00675000902
- ER 11** 411007001-65 1:2 EC  
00675000914
- ER 11** 411007000-65 1:2 IC 80 bar  
00675000914

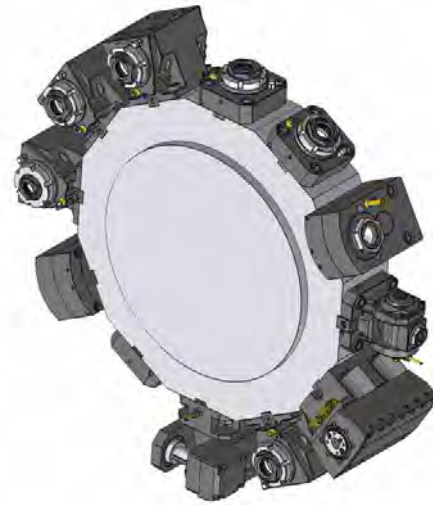
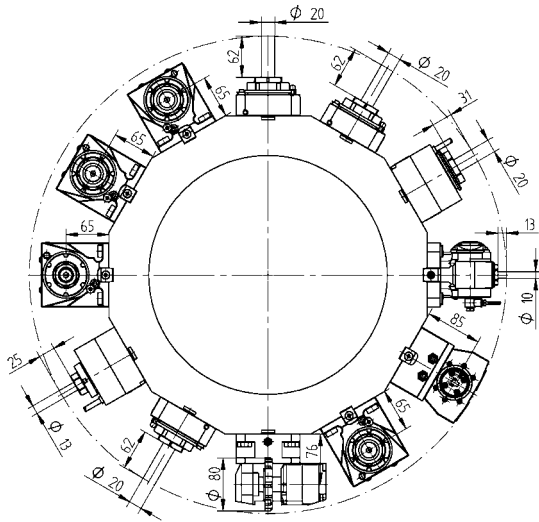



Driven Toolholders - Enhanced Program





**Offset slitting saw unit**

**Type 14-2** 411500001-65 2.73:1 EC

 00675000448

 160016142 Ø 16

 160022142 Ø 22

 160027142 Ø 27

 160015142 Ø 5/8"

 160019142 Ø 3/4"

 160023142 Ø 7/8"

 160025142 Ø 1"



**Broaching unit for ID and OD**

**TN765050** 414532003-65 1:1 EC

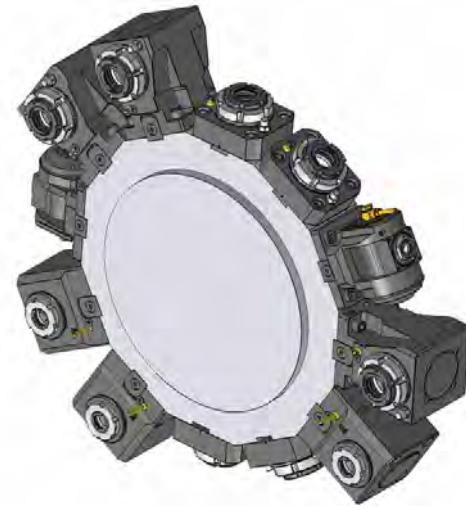
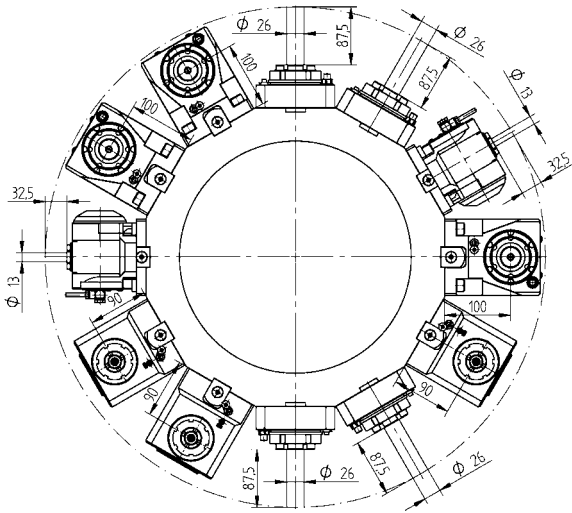

Driven Toolholders - QuickFlex®



**Straight drill/milling unit**

**ER-40 QF** 420140010-75 1:1 EC  
 0067740000

**ER-40 QF** 420140011-75 1:1 IC 80 bar  
 0067740000



**Right angle drill/milling unit**

**ER-40 QF** 420540010-75 1:1 EC  
 0067740000

**ER-40 QF** 420540011-75 1:1 IC 80 bar  
 0067740000

Driven Toolholders - Enhanced Program



**Right angle drill/milling unit**

**ER 25** 410516000-75 1:2 EC  
 00675000897

**ER 25** 410516001-75 1:2 IC 80 bar  
 00675000897



**Adjustable angle drill/milling unit**

**ER 20** 411013000-75 1:1 EC  
 00675000928

**ER 20** 411013001-75 1:1 IC 80 bar  
 00675000928

**ER 16** 411010000-75 1:2 EC  
 00675000936

**ER 16** 411010001-75 1:2 IC 80 bar  
 00675000936

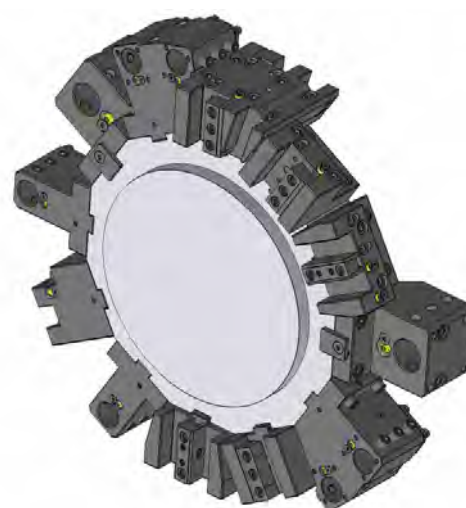
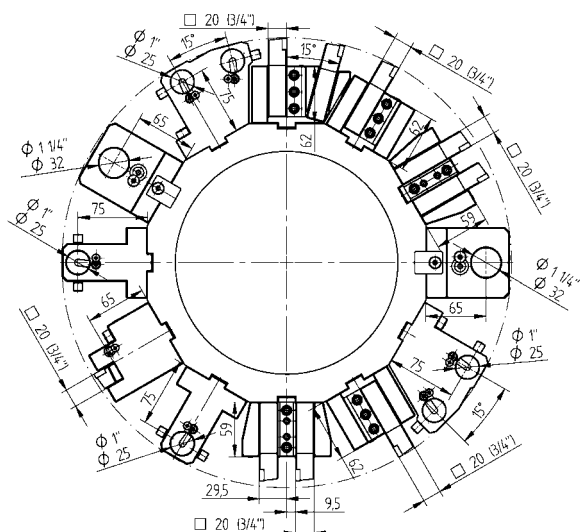



Static Toolholders - Standard Program

- 

**OD cutting holder**  
 20 48-101470  
 Z90-86304-00  
 3/4" 48-104496
- 

**OD cutting holder, HP-IC**  
 20 48-101470-HP IC 80 bar  
 3/4" 48-104496-HP IC 80 bar
- 

**OD cutting holder, both sides**  
 20 48-101471  
 Z90-86303-00  
 3/4" 48-104755
- 

**Face cutting holder**  
 20 48-102352  
 Z90-86301-00  
 3/4" 48-104735
- 

**Combination toolholder, LF=75**  
 Ø 25 48-101472  
 Z90-86302-00  
 Ø 1" 48-104526
- 

**Combination toolholder**  
 Ø 32 48-107155  
 Ø 1 1/4" 48-107260

Static Toolholders - Enhanced Program

- 

**OD cutting holder, double, Y axis**  
 20 48-101473  
 Z90-86548-00  
 3/4" 48-104523
- 

**OD cutting holder, both sides, double, 24 station (only for turret size 300)**  
 20 48-107973 EC  
 3/4" 48-108110 EC
- 

**Cut-off holder**  
 SH 26 48-100419  
 Z90-86307-00
- 

**Cut-off holder, HP-IC**  
 SH 26 48-102274R IC 80 bar  
 SH 26 48-102274L IC 80 bar  
 SH 32 48-112233R IC 80 bar  
 343-810100R95  
 SH 32 48-112233L IC 80 bar  
 343-810100L95
- 

**Combination toolholder, universal, double, 24 station (only for turret size 300)**  
 Ø 25 48-107985 IC 80 bar  
 Ø 1" 48-108111 IC 80 bar

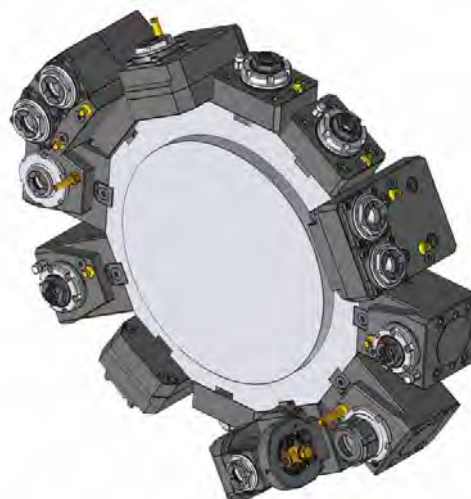
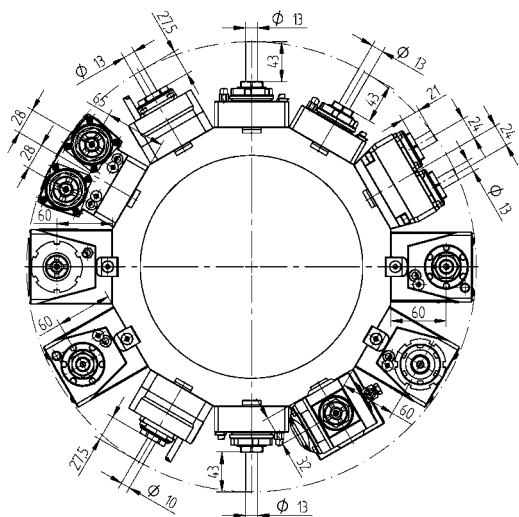

Driven Toolholders - QuickFlex®

- 

**Straight drill/milling unit**

<b>ER-20 QF</b>	420120010-44	1:1	EC
	Z90-86300-00		
	 0067720000		
<b>ER-20 QF</b>	420120011-44	1:1	IC 80 bar
	Z90-86300-00		
	 0067720000		
  
- 

**Right angle drill/milling unit, LF=60**

<b>ER-20 QF</b>	420520010-44	1:1	EC
	Z90-86299-00		
	 0067720000		
<b>ER-20 QF</b>	420520011-44	1:1	IC 80 bar
	Z90-86299-00		
	 0067720000		
  
- 

**Right angle drill/milling unit, both sides, LF=60**

<b>ER-20 QF</b>	420520012-44	1:1	EC
	Z90-86299-00		
	 0067720000		

Driven Toolholders - Enhanced Program

- 



**Straight drill/milling unit**

<b>ER 25</b>	410116004-44	1:1	EC
	Z90-86305-00		
	 00675000720		
<b>ER 25</b>	410116002-44	1:1	IC 80 bar
	Z90-86305-00		
	 00675000720		
  
- 

**Straight offset drill/milling unit**

<b>ER 20</b>	410113004-44	1:2	EC
	Z90-89788-00		
	 00675000939		
<b>ER 16</b>	410110002-44	1:3	EC
	Z90-89788-00		
	 00675000937		
<b>ER 25</b>	410116005-44	1.5:1	EC
	Z90-89788-00		
	 00675000932		
  
- 

**Right angle drill/milling unit, LF=60**

<b>ER 25</b>	410516005-44	1:1	EC
	Z90-86306-00		
	 00675000720		
<b>ER 25</b>	410516006-44	1:1	IC 80 bar
	Z90-86306-00		
	 00675000720		
<b>ER 20</b>	410513002-44	1:2	EC
	Z90-89789-00		
	 00675000833		
<b>ER 20</b>	410513003-44	1:2	IC 80 bar
	Z90-89789-00		
	 00675000833		
<b>ER 16</b>	410810006-44	1:3	EC
	Z90-89789-00		
	 00675000841		
<b>ER 16</b>	410810007-44	1:3	IC 80 bar
	Z90-89789-00		
	 00675000841		
<b>ER 25</b>	410516002-44	2:1	EC
	Z90-86306-00		
	 00675000720		
<b>ER 25</b>	410516003-44	2:1	IC 80 bar
	Z90-86306-00		
	 00675000720		



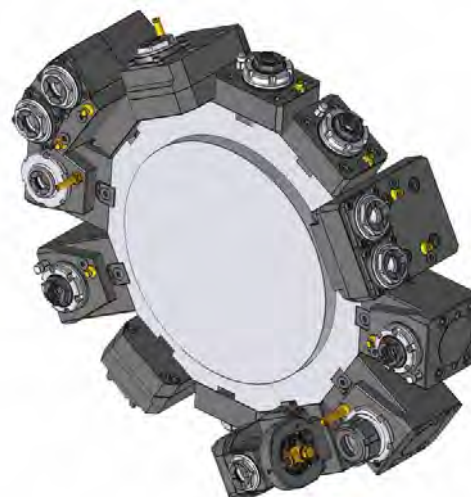
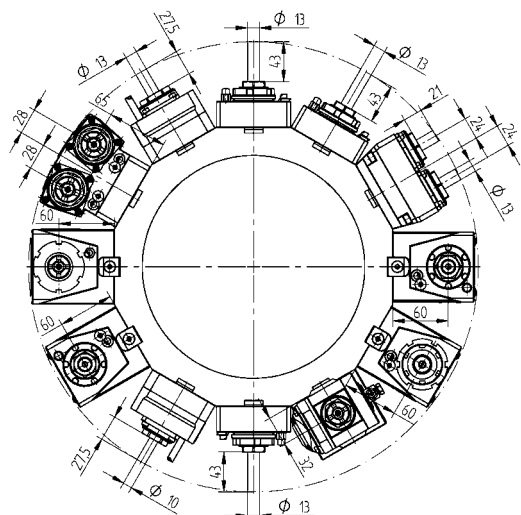

Driven Toolholders - Enhanced Program



**Right angle milling unit with combination mill arbor DIN 6358, LF=60**

<b>Ø 22</b>	410622000-44	1:1	EC
	00675000483		
<b>Ø 22</b>	410622001-44	2:1	EC
	00675000483		



**Adjustable angle drill/milling unit**

<b>ER 16</b>	411010004-44	1:1	EC
	Z90-89787-00		
	00675000902		
<b>ER 16</b>	411010005-44	1:1	IC 80 bar
	00675000902		
<b>ER 11</b>	411007006-44	1:2	EC
	00675000914		
<b>ER 11</b>	411007007-44	1:2	IC 80 bar
	00675000914		



**Straight drill/milling unit, double, Y axis**

<b>ER 20</b>	413002003-44	1:1	EC
	00675000939		
<b>ER 20</b>	413002004-44	1:1	IC 80 bar
	00675000939		







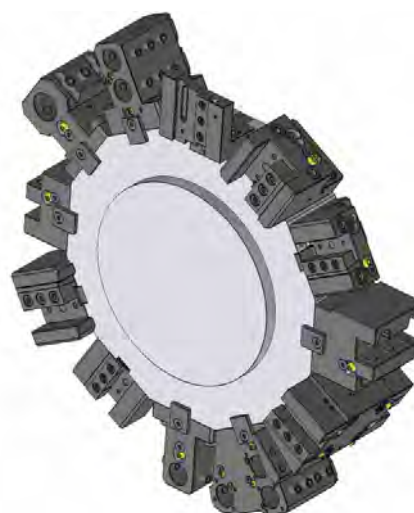
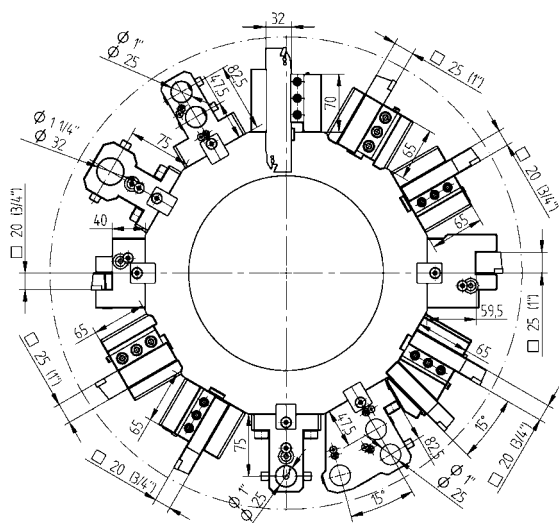

**2-spindle - Right angle drill/milling unit, Y axis**









<b>ER 20</b>	413502004-44	1:1	EC
	00675000939		
<b>ER 20</b>	413502005-44	1:1	IC 80 bar
	00675000939		



Static Toolholders - Standard Program

	<b>OD cutting holder</b>		
	20	48-108585	
	3/4"	48-108586	
	25	48-106720	
	<b>OD cutting holder, HP-IC</b>		
	25	48-106720-HP	IC 80 bar
	1"	48-106730-HP	IC 80 bar
	<b>OD cutting holder, both sides</b>		
	20	48-108460	
	3/4"	48-108588	
	<b>Face cutting holder</b>		
	20	48-108590	
	3/4"	48-108591	
	<b>Face cutting holder</b>		
	25	48-107758	
	1"	48-107759	
	<b>Combination toolholder</b>		
	Ø 25	48-107842	
	Ø 1"	48-107879	
	Ø 32	48-106727	
	1 1/4"	48-106734	

Static Toolholders - Enhanced Program

	<b>OD cutting holder, double, 24 station (only for turret size 340)</b>		
	20	48-108592	EC
	3/4"	48-108593	EC
	<b>OD cutting holder, both sides, double, 24 station (only for turret size 340)</b>		
	20	48-108461	EC
	3/4"	48-108595	EC
	<b>Cut-off holder</b>		
	SH 32	48-99637	
	<b>Cut-off holder, HP-IC</b>		
	SH 32	48-102276R	IC 80 bar
	SH 32	48-102276L	IC 80 bar
	<b>Cut-off holder, adjustable</b>		
	SH 32	48-110366	EC
	<b>Cut-off holder, adjustable, HP-IC</b>		
	SH 32	48-109656L	IC 80 bar
		343-810100L87	
	SH 32	48-109656R	IC 80 bar
		343-810100R87	
	<b>Combination toolholder, double</b>		
	Ø 25	48-108596	IC 80 bar
	Ø 1"	48-108597	IC 80 bar
	<b>Combination toolholder, universal, triple, 24 station (only for turret size 340)</b>		
	Ø 25	48-108462	IC 80 bar
	Ø 1"	48-108599	IC 80 bar

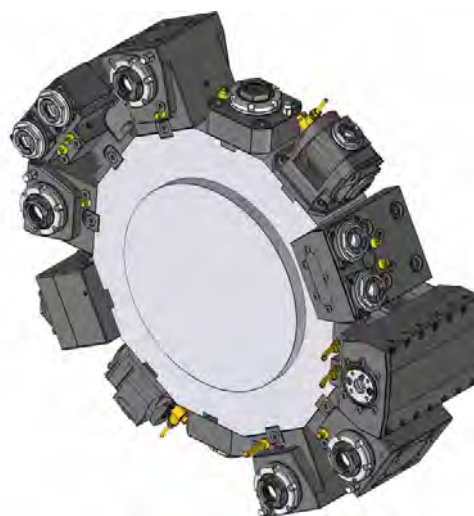
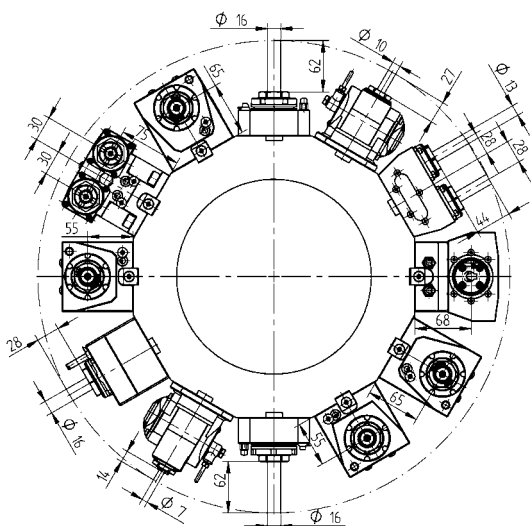

Driven Toolholders - QuickFlex®

	<b>Straight drill/milling unit</b>			
	<b>ER-25 QF</b>	420125022-55	1:1	EC
		0067725000		
	<b>ER-25 QF</b>	420125023-55	1:1	IC 80 bar
		0067725000		
	<b>Right angle drill/milling unit, LF=55</b>			
	<b>ER-25 QF</b>	420525087-55	1:1	EC
		0067725000		
	<b>ER-25 QF</b>	420525088-55	1:1	IC 80 bar
		0067725000		
	<b>Right angle drill/milling unit, LF=65</b>			
	<b>ER-25 QF</b>	420525085-55	1:1	EC
		0067725000		
	<b>ER-25 QF</b>	420525086-55	1:1	IC 80 bar
		0067725000		
	<b>Right angle drill/milling unit, both sides, LF=55</b>			
	<b>ER-25 QF</b>	420525069-55	1:1	EC
		0067725000		
	<b>Right angle drill/milling unit, both sides, LF=65</b>			
	<b>ER-25 QF</b>	420525077-55	1:1	EC
		0067725010		

Driven Toolholders - Enhanced Program

	<b>Straight drill/milling unit</b>			
	<b>ER 32</b>	410120002-55	1:1	EC
		0067825000		
	<b>ER 32</b>	410120003-55	1:1	IC 80 bar
		0067825000		
	<b>Straight milling unit</b>			
	<b>Ø 22</b>	410222002-55	1:1	EC
		00675000483		
	<b>Ø 3/4"</b>	410219000-55	1:1	EC
		00675000854		
	<b>Straight offset drill/milling unit</b>			
	<b>ER 25</b>	410116027-55	1:1	EC
		00675000932		
	<b>ER 25</b>	410116028-55	1:1	IC 80 bar
		00675000932		
	<b>ER 20</b>	410113006-55	1:2	EC
		00675000939		
	<b>ER 20</b>	410113004-55	1:2	IC 80 bar
		00675000939		
	<b>ER 16</b>	410410000-55	1:3	EC
		00675000937		
	<b>ER 16</b>	410410001-55	1:3	IC 80 bar
		00675000937		
	<b>ER 25</b>	410116021-55	2:1	EC
		00675000932		
	<b>ER 25</b>	410116022-55	2:1	IC 80 bar
		00675000932		

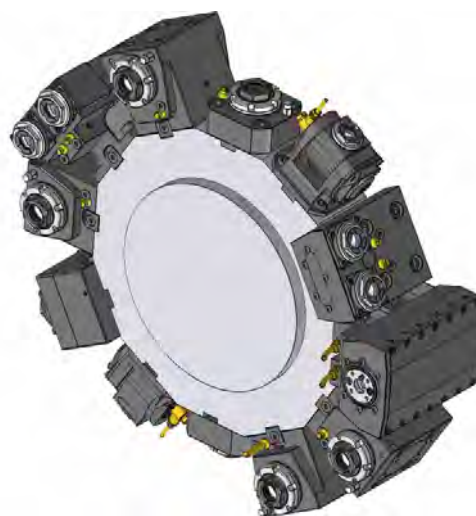
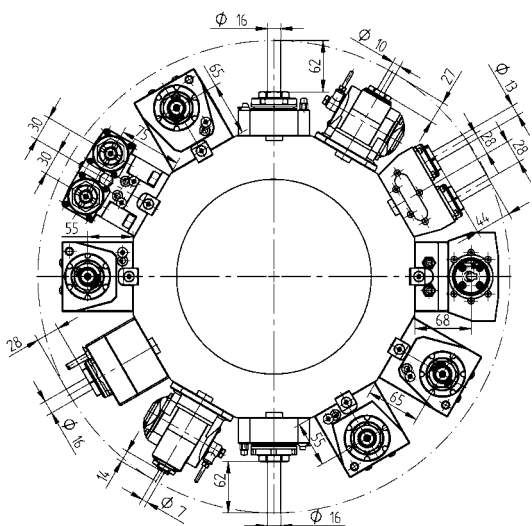

Driven Toolholders - Enhanced Program



**Right angle drill/milling unit, LF=65**

<b>ER 32</b>	410520045-55	1:1	EC
	0067825000		
<b>ER 32</b>	410520046-55	1:1	IC 80 bar
	0067825000		
<b>ER-20 QF</b>	420520029-55	1:2	EC
	0067720001		
<b>ER-20 QF</b>	420520030-55	1:2	IC 80 bar
	0067720001		
<b>ER 16</b>	410810022-55	1:3	EC
	00675000841		
<b>ER 16</b>	410810023-55	1:3	IC 80 bar
	00675000841		
<b>ER-25 QF</b>	420525055-55	2:1	EC
	0067725000		
<b>ER-25 QF</b>	420525056-55	2:1	IC 80 bar
	0067725000		



**Right angle milling unit with combination mill arbor DIN 6358, LF=65**

<b>Ø 22</b>	410622013-55	1:1	EC
	00675000483		
<b>Ø 22</b>	410622007-55	2:1	EC
	00675000483		
<b>Ø 3/4"</b>	410619008-55	1:1	EC
	00675000483		

Driven Toolholders - Enhanced Program



**Right angle back set drill/milling unit, LF=65**

<b>ER 32</b>	410520007-55	1:1	EC
	00675000592		
<b>ER 32</b>	410520008-55	1:1	IC 80 bar
	00675000592		
<b>ER 32</b>	410520009-55	2:1	EC
	00675000592		
<b>ER 32</b>	410520010-55	2:1	IC 80 bar
	00675000592		



**Adjustable angle drill/milling unit**

<b>ER 16</b>	411010001-55	1:1	EC
	00675000902		
<b>ER 16</b>	411010002-55	1:1	IC 80 bar
	00675000902		
<b>ER 11</b>	411007003-55	1:2	EC
	00675000914		
<b>ER 11</b>	411007004-55	1:2	IC 80 bar
	00675000914		



**Slitting saw unit**

<b>Type 14-2</b>	411500000-55	2.73:1	EC
	00675000489		
	160016142 Ø 16		
	160022142 Ø 22		
	160027142 Ø 27		
	160015142 Ø 5/8"		
	160019142 Ø 3/4"		
	160023142 Ø 7/8"		
	160025142 Ø 1"		



**Straight drill/milling unit, double, Y axis**

<b>ER 20</b>	413002001-55	1:1	EC
	00675000944		

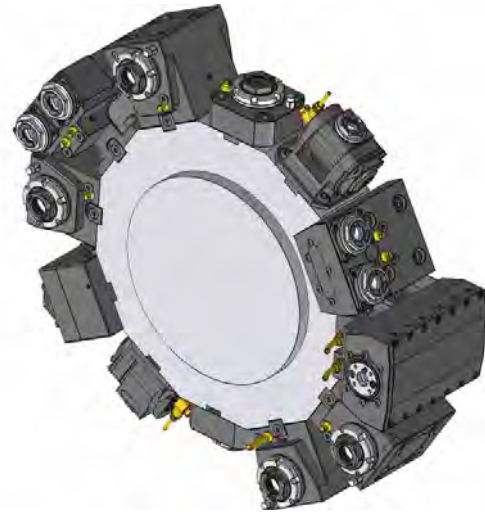
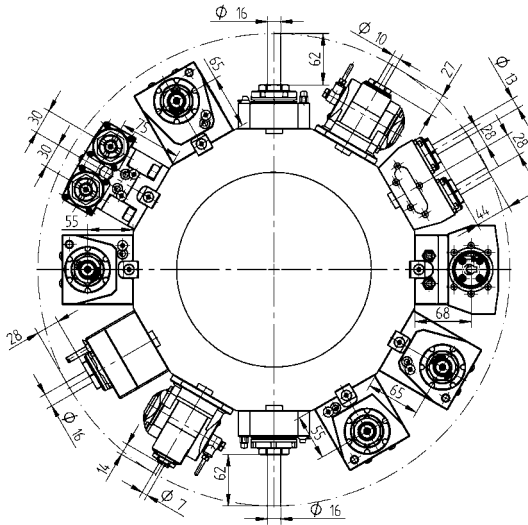

Driven Toolholders - Enhanced Program



**2-spindle - Right angle drill/milling unit, Y axis**

**ER 20** 413502012-55 1:1 EC  
 00675000944



**Broaching unit for ID and OD**

**TN765050** 414532003-55 1:1 EC



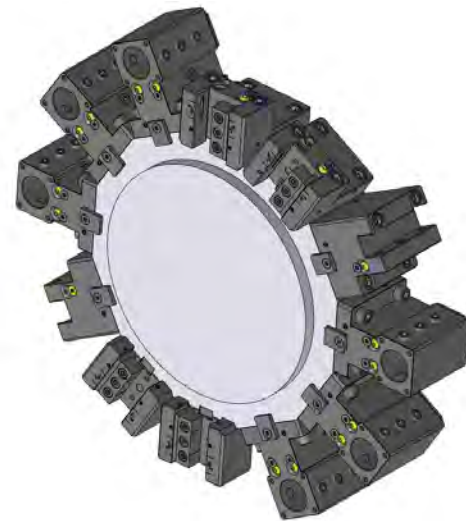
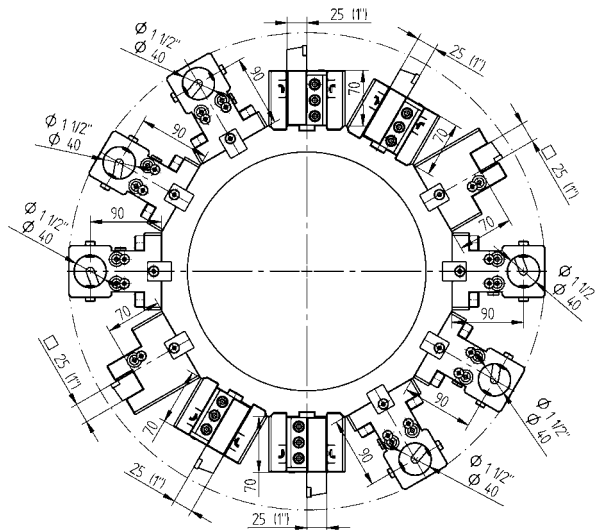

Static Toolholders - Standard Program

Static Toolholders - Enhanced Program

- 



**OD cutting holder, HP-IC**

<b>25</b>	48-107657-HP	IC 80 bar
<b>1"</b>	48-107658-HP	IC 80 bar
  
- 

**Face cutting holder, HP-IC**

<b>25</b>	48-113236-HP	IC 80 bar
<b>1"</b>	48-113237-HP	IC 80 bar
  
- 

**Combination toolholder**

<b>Ø 40</b>	48-107659	
	 241140020 ER32	
	 241140026 ER40	
<b>Ø 1 1/2"</b>	48-107660	
	 2411150020 ER32	

- 

**Cut-off holder**

<b>SH 32</b>	48-100204	
--------------	-----------	--
  
- 

**Cut-off holder, HP-IC**

<b>SH 32</b>	48-102279R	IC 80 bar
<b>SH 32</b>	48-102279L	IC 80 bar

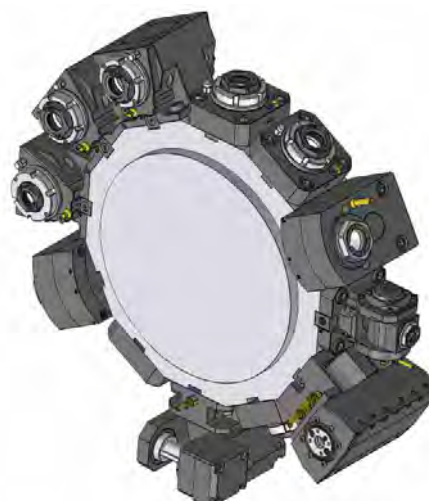
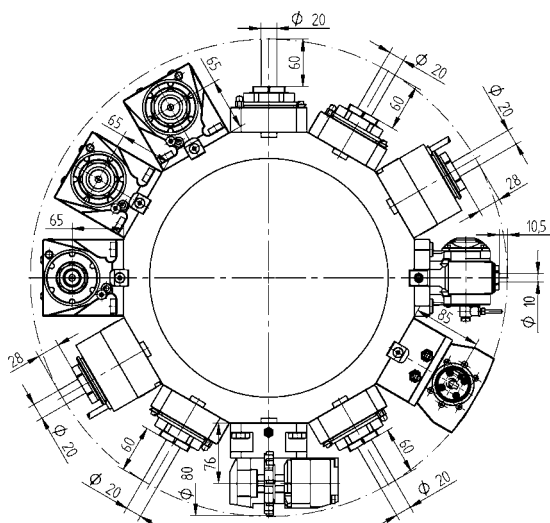



Driven Toolholders - QuickFlex®



Driven Toolholders - Enhanced Program

- 

**Straight drill/milling unit**

<b>ER-32 QF</b>	420132019-65	1:1	EC
	 0067732000		
<b>ER-32 QF</b>	420132020-65	1:1	IC 80 bar
	 0067732000		
- 

**Right angle drill/milling unit**





<b>ER-32 QF</b>	420532025-65	1:1	EC
	 0067732000		
<b>ER-32 QF</b>	420532026-65	1:1	IC 80 bar
	 0067732000		
- 

**Right angle drill/milling unit, both sides**





<b>ER-32 QF</b>	420532043-65	1:1	EC
	 0067732000		

- 





**Straight offset drill/milling unit**

<b>ER 32</b>	410120030-65	1:1	EC
	 00675000958		
<b>ER 32</b>	410120031-65	1:1	IC 80 bar
	 00675000958		
<b>ER 20</b>	410113002-65	1:2	EC
	 00675000591		
<b>ER 20</b>	410113003-65	1:2	IC 80 bar
	 00675000591		
- 

**Right angle drill/milling unit**

<b>ER-25 QF</b>	420525014-65	1:2	EC
	 0067725001		
<b>ER-25 QF</b>	420525015-65	1:2	IC 80 bar
	 0067725001		
<b>ER-32 QF</b>	420532031-65	2:1	EC
	 0067732000		
<b>ER-32 QF</b>	420532032-65	2:1	IC 80 bar
	 0067732000		
- 

**Adjustable angle drill/milling unit**

<b>ER 16</b>	411010000-65	1:1	EC
	 00675000902		
<b>ER 16</b>	411010001-65	1:1	IC 80 bar
	 00675000902		
<b>ER 11</b>	411007001-65	1:2	EC
	 00675000914		
<b>ER 11</b>	411007000-65	1:2	IC 80 bar
	 00675000914		

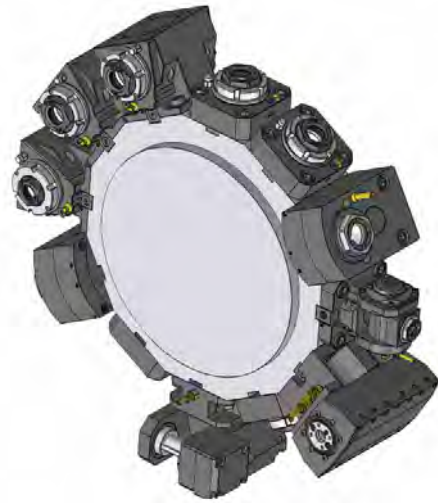
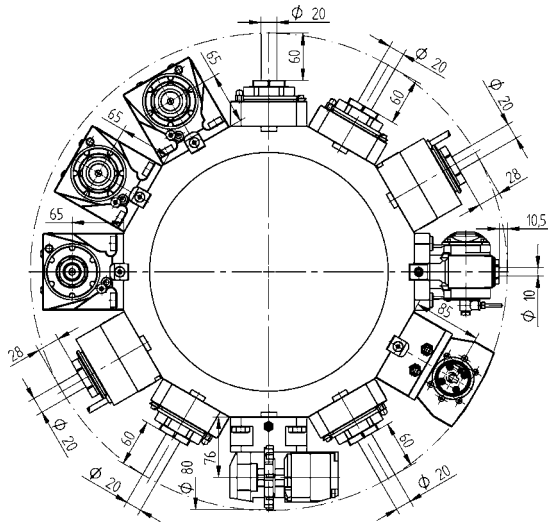



Driven Toolholders - Enhanced Program





**Offset slitting saw unit**

**Type 14-2** 411500001-65 2.73:1 EC

 00675000448

 160016142 Ø 16

 160022142 Ø 22

 160027142 Ø 27

 160015142 Ø 5/8"

 160019142 Ø 3/4"

 160023142 Ø 7/8"

 160025142 Ø 1"



**Broaching unit for ID and OD**

**TN765050** 414532003-65 1:1 EC

Standard reduction sleeves - cylindrical



**Reduction sleeve Ø 25**

240025006	ø 6
240025008	ø 8
240025010	ø 10
240025012	ø 12
240025016	ø 16
240025020	ø 20



**Reduction sleeve Ø 32**

240032006	ø 6
240032008	ø 8
240032010	ø 10
240032012	ø 12
240032016	ø 16
240032020	ø 20
240032025	ø 25



**Reduction sleeve Ø 40**

240040006	ø 6
240040008	ø 8
240040010	ø 10
240040012	ø 12
240040014	ø 14
240040016	ø 16
240040020	ø 20
240040025	ø 25
240040032	ø 32



**Reduction sleeve Ø 1"**

2400100025	ø 1/4"
2400100031	ø 5/16"
2400100038	ø 3/8"
2400100050	ø 1/2"
2400100063	ø 5/8"
2400100075	ø 3/4"



**Reduction sleeve Ø 1 1/4"**

2400125038	ø 3/8"
2400125050	ø 1/2"
2400125063	ø 5/8"
2400125075	ø 3/4"
2400125088	ø 7/8"
2400125100	ø 1"



**Reduction sleeve Ø 1 1/2"**

2400150038	ø 3/8"
2400150050	ø 1/2"
2400150063	ø 5/8"
2400150075	ø 3/4"
2400150088	ø 7/8"
2400150100	ø 1"
2400150125	ø 1 1/4"

Standard reduction sleeves - morse taper



**Reduction sleeve Ø 32**

240532001	MT 1
240532002	MT 2
240532003	MT 3



**Reduction sleeve Ø 40**

240540001	MT 1
240540002	MT 2
240540003	MT 3
240540004	MT 4



**Reduction sleeve Ø 50**

240550002	MT 2
240550003	MT 3
240550004	MT 4

Collets DIN 6499B (ER/ESX)



ER 11	mm	inch
190011000	ø 7-0.5	ø 0.276-0.020
190011010	ø 1-0.5	ø 0.039-0.020
190011015	ø 1.5-1	ø 0.059-0.039
190011020	ø 2-1.5	ø 0.079-0.059
190011025	ø 2.5-2	ø 0.098-0.079
190011030	ø 3-2.5	ø 0.118-0.098
190011035	ø 3.5-3	ø 0.138-0.118
190011040	ø 4-3.5	ø 0.158-0.138
190011045	ø 4.5-4	ø 0.177-0.158
190011050	ø 5-4.5	ø 0.197-0.177
190011055	ø 5.5-5	ø 0.217-0.197
190011060	ø 6-5.5	ø 0.236-0.217
190011065	ø 6.5-6	ø 0.256-0.236
190011070	ø 7-6.5	ø 0.276-0.256



ER 16	mm	inch
190016000	ø 10-0.5	ø 0.394-0.020
190016010	ø 1-0.5	ø 0.039-0.020
190016020	ø 2-1	ø 0.079-0.039
190016030	ø 3-2	ø 0.118-0.079
190016040	ø 4-3	ø 0.158-0.118
190016050	ø 5-4	ø 0.197-0.158
190016060	ø 6-5	ø 0.236-0.197
190016070	ø 7-6	ø 0.276-0.236
190016080	ø 8-7	ø 0.315-0.276
190016090	ø 9-8	ø 0.354-0.315
190016100	ø 10-9	ø 0.394-0.354



ER 20	mm	inch
190020000	ø 13-1	ø 0.512-0.039
190020010	ø 1-0.5	ø 0.039-0.020
190020020	ø 2-1	ø 0.079-0.039
190020030	ø 3-2	ø 0.118-0.079
190020040	ø 4-3	ø 0.157-0.118
190020050	ø 5-4	ø 0.197-0.157
190020060	ø 6-5	ø 0.236-0.197
190020070	ø 7-6	ø 0.276-0.236
190020080	ø 8-7	ø 0.315-0.276
190020090	ø 9-8	ø 0.354-0.315
190020100	ø 10-9	ø 0.394-0.354
190020110	ø 11-10	ø 0.433-0.394
190020120	ø 12-11	ø 0.472-0.433
190020130	ø 13-12	ø 0.512-0.472

Collets DIN 6499B (ER/ESX)



ER 25	mm	inch
190025000	ø 16-1	ø 0.630-0.039
190025020	ø 2-1	ø 0.079-0.039
190025030	ø 3-2	ø 0.118-0.079
190025040	ø 4-3	ø 0.157-0.118
190025050	ø 5-4	ø 0.197-0.157
190025060	ø 6-5	ø 0.236-0.197
190025070	ø 7-6	ø 0.276-0.236
190025080	ø 8-7	ø 0.315-0.276
190025090	ø 9-8	ø 0.354-0.315
190025100	ø 10-9	ø 0.394-0.354
190025110	ø 11-10	ø 0.433-0.394
190025120	ø 12-11	ø 0.472-0.433
190025130	ø 13-12	ø 0.512-0.472
190025140	ø 14-13	ø 0.551-0.512
190025150	ø 15-14	ø 0.591-0.551
190025160	ø 16-15	ø 0.630-0.591



ER 32	mm	inch
190032000	ø 20-2	ø 0.787-0.079
190032030	ø 3-2	ø 0.118-0.079
190032040	ø 4-3	ø 0.157-0.118
190032050	ø 5-4	ø 0.197-0.157
190032060	ø 6-5	ø 0.236-0.197
190032070	ø 7-6	ø 0.276-0.236
190032080	ø 8-7	ø 0.315-0.276
190032090	ø 9-8	ø 0.354-0.315
190032100	ø 10-9	ø 0.394-0.354
190032110	ø 11-10	ø 0.433-0.394
190032120	ø 12-11	ø 0.472-0.433
190032130	ø 13-12	ø 0.512-0.472
190032140	ø 14-13	ø 0.551-0.512
190032150	ø 15-14	ø 0.591-0.551
190032160	ø 16-15	ø 0.630-0.591
190032170	ø 17-16	ø 0.669-0.630
190032180	ø 18-17	ø 0.709-0.669
190032190	ø 19-18	ø 0.748-0.709
190032200	ø 20-19	ø 0.787-0.748



Collets DIN 6499B (ER/ESX)



ER 40	mm	inch
190040000	∅ 26-3	∅ 1.024-0.118
190040040	∅ 4-3	∅ 0.157-0.118
190040050	∅ 5-4	∅ 0.197-0.157
190040060	∅ 6-5	∅ 0.236-0.197
190040070	∅ 7-6	∅ 0.276-0.236
190040080	∅ 8-7	∅ 0.315-0.276
190040090	∅ 9-8	∅ 0.354-0.315
190040100	∅ 10-9	∅ 0.394-0.354
190040110	∅ 11-10	∅ 0.433-0.394
190040120	∅ 12-11	∅ 0.472-0.433
190040130	∅ 13-12	∅ 0.512-0.472
190040140	∅ 14-13	∅ 0.551-0.512
190040150	∅ 15-14	∅ 0.591-0.551
190040160	∅ 16-15	∅ 0.630-0.591
190040170	∅ 17-16	∅ 0.669-0.630
190040180	∅ 18-17	∅ 0.709-0.669
190040190	∅ 19-18	∅ 0.748-0.709
190040200	∅ 20-19	∅ 0.787-0.748
190040210	∅ 21-20	∅ 0.827-0.787
190040220	∅ 22-21	∅ 0.866-0.827
190040230	∅ 23-22	∅ 0.906-0.866
190040240	∅ 24-23	∅ 0.945-0.906
190040250	∅ 25-24	∅ 0.984-0.945
190040260	∅ 26-25	∅ 1.024-0.984

Collets DIN 6499D (ER/ESX) - sealed, for IC



ER 11	mm	inch
191011030	∅ 3	
191011040	∅ 4	
191011050	∅ 5	
191011060	∅ 6	
191111013-in		∅ 0.125
191111019-in		∅ 0.188
191111025-in		∅ 0.25



ER 16	mm	inch
191016000	∅ 3-10	
191016030	∅ 3	
191016040	∅ 4	
191016050	∅ 5	
191016060	∅ 6	
191016070	∅ 7	
191016080	∅ 8	
191016090	∅ 9	
191016100	∅ 10	
191116001		∅ 0.125-0.375
191116013-in		∅ 0.125
191116019-in		∅ 0.188
191116025-in		∅ 0.25
191116031-in		∅ 0.313
191116038-in		∅ 0.375



ER 20	mm	inch
191020000	∅ 3-12	
191020030	∅ 3	
191020040	∅ 4	
191020050	∅ 5	
191020060	∅ 6	
191020070	∅ 7	
191020080	∅ 8	
191020090	∅ 9	
191020100	∅ 10	
191020110	∅ 11	
191020120	∅ 12	
191120001		∅ 0.125-0.5
191120013-in		∅ 0.125
191120019-in		∅ 0.188
191120025-in		∅ 0.25
191120031-in		∅ 0.313
191120038-in		∅ 0.375
191120044-in		∅ 0.438
191120050-in		∅ 0.5

Collets DIN 6499D (ER/ESX) - sealed, for IC

Collets DIN 6499D (ER/ESX) - sealed, for IC



ER 25	mm	inch
191025000	ø 4-16	
191025030	ø 3	
191025040	ø 4	
191025050	ø 5	
191025060	ø 6	
191025070	ø 7	
191025080	ø 8	
191025090	ø 9	
191025100	ø 10	
191025110	ø 11	
191025120	ø 12	
191025130	ø 13	
191025140	ø 14	
191025150	ø 15	
191025160	ø 16	
191125001		ø 0.25-0.625
191125025-in		ø 0.25
191125031-in		ø 0.313
191125038-in		ø 0.375
191125044-in		ø 0.438
191125050-in		ø 0.5
191125056-in		ø 0.563
191125063-in		ø 0.625



ER 40	mm	inch
191040060	ø 6	
191040080	ø 8	
191040100	ø 10	
191040120	ø 12	
191040140	ø 14	
191040160	ø 16	
191040180	ø 18	
191040200	ø 20	
191040220	ø 22	
191040250	ø 25	
191140025-in		ø 0.25
191140031-in		ø 0.313
191140038-in		ø 0.375
191140044-in		ø 0.438
191140050-in		ø 0.5
191140056-in		ø 0.563
191140063-in		ø 0.625
191140069-in		ø 0.688
191140075-in		ø 0.75
191140088-in		ø 0.875
191140100-in		ø 1



ER 32	mm	inch
191032000	ø 4-20	
191032030	ø 3	
191032040	ø 4	
191032050	ø 5	
191032060	ø 6	
191032070	ø 7	
191032080	ø 8	
191032090	ø 9	
191032100	ø 10	
191032110	ø 11	
191032120	ø 12	
191032130	ø 13	
191032140	ø 14	
191032150	ø 15	
191032160	ø 16	
191032170	ø 17	
191032180	ø 18	
191032190	ø 19	
191032200	ø 20	
191132001		ø 0.25-0.75
191132025-in		ø 0.25
191132031-in		ø 0.313
191132038-in		ø 0.375
191132044-in		ø 0.438
191132050-in		ø 0.5
191132056-in		ø 0.563
191132063-in		ø 0.625
191132069-in		ø 0.688
191132075-in		ø 0.75





## Quality without compromise.

All manufacturing steps are based on highest precision.

According to our own device that for the manufacture of high precision tooling systems high precision machine tools are essential we only use the latest machine tool technology to manufacture our parts.

At WTO not only the final products but also all manufacturing steps are checked and documented. All our products are measured on high precision 3D-coordinate-measuring machines.

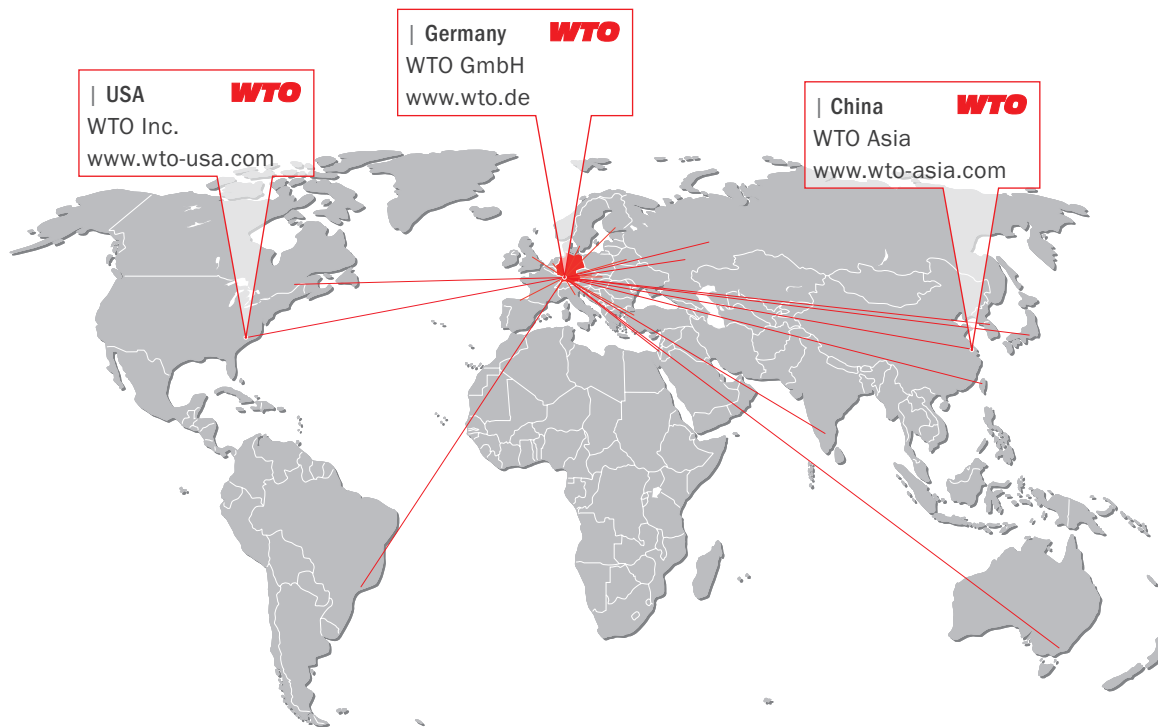

| USA **WTO**  
WTO Inc.  
www.wto-usa.com

| Germany **WTO**  
WTO GmbH  
www.wto.de

| China **WTO**  
WTO Asia  
www.wto-asia.com

WTO GmbH  
Auf der oberen Au 45  
77797 Ohlsbach  
Germany

WTO USA  
13900-F  
South Lakes Drive  
Charlotte, NC 28273  
USA

WTO Asia  
Room 109-110, Building 2  
No. 228 Banting Road  
Jiuting Town,  
Songjiang District  
201615 Shanghai  
China

## Our distribution partners. Competence right there.

| Australia  
Dimac Tooling Ltd.  
sales@dimac.com.au

| Finland  
Suomen Terästuonti Oy  
myynti@stt.as

| Korea  
WTO Office Korea  
is.chon@wto-korea.com

| Slovakia  
ALBA precision s.r.o.  
albaprecision@albaprecision.sk

| Belarus  
LLC "PMI Engineering"  
tool@pmi.by

| France  
Philippe Tagliafero  
pta@wto.de

| Mexico  
Workholding Engineering De México  
info@wem.com.mx

| Spain  
ITALMATIC, S.A.  
italmatic@italmatic.es

| Brazil  
TF2  
tfdois@tfdois.com.br

| Great Britain  
Cutwel Ltd.  
sales@cutwel.net

| Netherlands  
Toologic BeNeLux B.V.  
info@toologic-benelux.nl

| Sweden  
Komet Scandinavia AB  
scandinavia@kometgroup.com

| Canada  
Mittmann Industrial Inc.  
info@mittmann.com

| India  
Ulhas Patil  
u.patil@wto-asia.com

| Norway  
Helge Karlsen Verktøy og Maskin AS  
hkvm@hkvm.no

| Switzerland  
Utilis AG  
info@utilis.com

| China  
Shanghai Gangde  
wtocando@yahoo.com

| Israel  
E.Y.A.R. Ltd.  
boris@eyar.co.il

| Poland  
ARCO Andrzej Rudenko  
info@arcotools.pl

| Taiwan  
Kaiko Co., Ltd.  
info@kaiko.com.tw

| Czech Republic  
ALBA precision, spol. s.r.o.  
info@albaprecision.cz

| Italy  
Prymark srl  
commerciale@prymark.it

| Romania  
SC Elif Trading SRL  
bulent.ozkan@eliftrading.com

| Turkey  
MYK CNC MAKINA SAN. VE  
huseyin.tatlidil@mykcnc.com.tr

| Denmark  
Tool-part  
cj@tool-part.dk

| Japan  
NK Works Co. Ltd.  
k\_samba@nk-works.co.jp

| Russia  
WTO Office Russia  
office@wto-russia.com

| Ukraine  
„LLC“ SPA Stankopromimport  
info@phoenix-ua.com