



SWISS+TOOLS<sup>®</sup>

*S w i s s*  
**P S C**  
**2106**



**PWLN**  
Seite/page 7



**SVJB SVJC**  
Seite/page 11

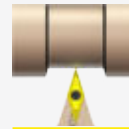

**SVVB SVVC**  
Seite/page 17

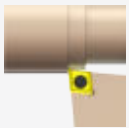

**SCLC**  
Seite/page 7



**SVPB SVJC**  
Seite/page 12

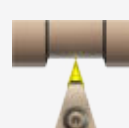

**DVVN**  
Seite/page 17

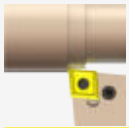

**PCLN**  
Seite/page 8

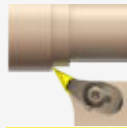

**DVPN**  
Seite/page 13



**Multitask Werkzeuge**  
Multitask tools  
Outils multitâches  
Seite/page 18-19



**SDUC**  
Seite/page 8

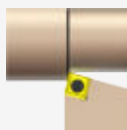

**SSBC**  
Seite/page 13



**Aussengewinde**  
External thread  
Filet extérieur  
Seite/page 20

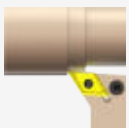

**PDUN**  
Seite/page 8

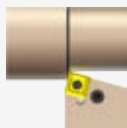

**PSBN**  
Seite/page 13



**Innengewinde**  
Internal thread  
Filet intérieur  
Seite/page 21

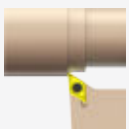

**SDJC**  
Seite/page 9



**SSSC**  
Seite/page 14

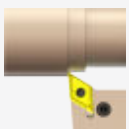

**PDJN**  
Seite/page 9

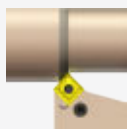

**PSSN**  
Seite/page 14

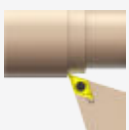

**SDHC**  
Seite/page 9

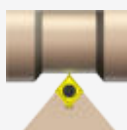

**SCMC**  
Seite/page 15

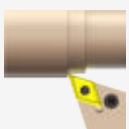

**PDHN**  
Seite/page 10



**PCMN PWMN**  
Seite/page 15



**SVUB SVUC**  
Seite/page 10

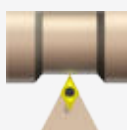

**SDNC**  
Seite/page 16



**DVUN**  
Seite/page 11



**PDNN**  
Seite/page 16



**Modulare Bohrstangen**  
Modular boring bars  
Barres d'alésage modulables  
Seite/page 22



**Bohrstangenhalter**  
Boring bar holder  
Porte-outils d'alésage  
Seite/page 28+29



**Verlängerung**  
Extension  
Extension  
Seite/page 36



**Schwingungs. Bohrstangen**  
Damped boring bar shanks  
Damped barres d'alésage  
Seite/page 23



**Wendeplattenbohrerhalter**  
Holder index. drill  
Porte-outils à plaq index.  
Seite/page 29



**Reduktion**  
Reduction  
Reduction  
Seite/page 36



**Wechselschneidköpfe**  
Exchangeable cutting heads  
Têtes de coupe interchangeable.  
Seite/page 24+25



**Abstechhalter radial**  
Cut-off block radial  
Bloc de tronçonnage radial  
Seite/page 30



**Verlängerung**  
Extension  
Extension  
Seite/page 37



**SCLC**  
Seite/page 26



**Abstechhalter axial**  
Cut-off block axial  
Bloc de tronçonnage axial  
Seite/page 31



**Trennstellenverschluss**  
Blanking plug  
Bouchon d'ébauche  
Seite/page 37



**PCLN**  
Seite/page 26



**Werkzeughalter radial**  
Tool holder radial  
Porte-outil radial  
Seite/page 32



**Kühlmittelrohr**  
Coolant tube  
tube d'arrosage  
Seite/page 37



**SDQC**  
Seite/page 27



**Werkzeughalter axial**  
Tool holder axial  
Porte-outil axial  
Seite/page 33



**Quick change Halter**  
Quick change holder  
Porte-outils à quick change  
Seite/page 43+44



**PDQN**  
Seite/page 27



**Werkzeughalter axial 2-fach**  
Tool holder axial double  
Porte-outil axial double  
Seite/page 34



**Schrumpffutter**  
Shrink chucks  
Porte outils à frettage  
Seite/page 45



**Werkzeughalter axial 3-fach**  
Tool holder axial triple  
Porte-outil axial triple  
Seite/page 34



**Ersatzteile**  
Spare parts  
Pièces de rechange  
Seite/page 46



**Werkzeughalter 45°**  
Tool holder 45°  
Porte-outil 45°  
Seite/page 35

## Bohrstangen mit Wechselschneidköpfen

- alle Wechselschneidköpfe sind mit Hochleistungskühlung ausgestattet.
- Werkzeugverschleiss tritt hauptsächlich am auswechselbaren Schneidkopf auf, der Adapter hält somit länger.
- In Kombination mit den SDT Bohrstangen ist das Konzept perfekt für Operationen mit langen Überhängen und bei Vibrationsneigung.

## Boring bars with exchangeable cutting heads

- all exchangeable cutting heads are equipped with high performance coolant.
- Tool wear appears mainly at the changeable head, the life time of the tool adapter is therefore longer.
- In combination with SDT the tool concept is perfect for long cantilever extensions and while fighting with vibrations.

## Barres d'alésage avec têtes de coupe interchangeables

- Toutes les têtes de coupe interchangeables sont équipées d'un arrosage haute performance.
- L'usure de l'outil apparaît principalement au niveau de la tête interchangeable, la durée de vie de l'adaptateur d'outil est donc plus longue.
- En combinaison avec SDT, le concept d'outil est parfait pour les longues extensions en porte-à-faux et tout en luttant contre les vibrations.



## SWISS DAMPENING TECHNOLOGY

### Schwingungsgedämpfte Bohrstangenschäfte

- Produktivitätsgewinn dank der unterdrückten Schwingungen können die Schnittdaten beträchtlich erhöht werden
- Verbesserte Oberflächengüte
- Verbesserte Prozesssicherheit
- Verbesserte Spanabfuhr
- Reduzierte Kosten pro Bauteil

### Damped boring bar shanks

- Productivity improvement: thanks to reduced vibrations, the cutting conditions can be improved remarkable
- Better surface quality
- Improved process stability
- Better chip evacuation
- Reduced cost per part

### Tiges de barres d'alésage anti-vibrations

- Amélioration de la productivité : grâce à la réduction des vibrations, les conditions de coupe peuvent être améliorées de façon remarquable.
- Meilleure qualité de surface
- Meilleure stabilité du processus
- Meilleure évacuation des copeaux
- Réduction du coût par pièce

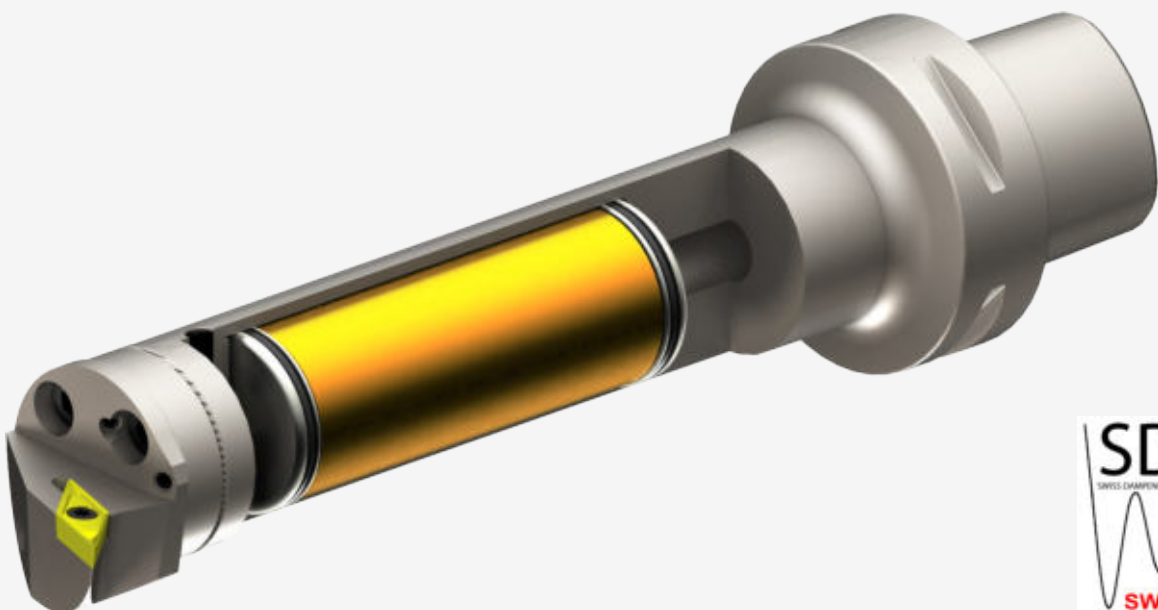

## Hochleistungskühlung

- für effiziente Drehbearbeitung
- optimale Kühlung durch fest ausgerichtete **High Pressure** Kühldüsen
- verbesserte Spankontrolle
- höhere Bearbeitungssicherheit
- mehr Zerspanvolumen
- kürzere Bearbeitungszeiten

## High performance coolant

- to turn efficiently
- optimal cooling by fix orientated **High Pressure** coolant nozzles
- improved chip control
- higher manufacturing security
- higher chip removal rate
- shorter machining time

## Arrosage haute performance

- pour des opérations de tournage efficaces
- arrosage optimal par des buses d'arrosage fixes High Pressure
- contrôle amélioré des copeaux
- plus grande sécurité d'usinage
- plus haut volume d'extraction de copeaux
- temps d'usinage plus courts

## Klemmhalter

- alle Klemmhalter die mit dem **HP** Symbol markiert sind, können auf Hochleistungskühlung aufgerüstet werden.

## Turning tool

- all turning tools which are marked with the **HP** symbol, can be set up with the high performance coolant.

## Outil de tournage

- Tous les outils de tournage, qui sont marqués avec ce symbole **HP**, peuvent être équipés avec le arrosage haute performance.



Bestell-Nr. /  
Order number/  
Code

CHP.PCX.000.022

- Hochleistungskühlmittel Set beinhaltet:
  - HP Düse
  - O-Ring

- High performance coolant set included:
  - HP coolant nozzle
  - O-ring

- Kit d'arrosage haute performance comprend
  - Buse HP
  - O-Ring

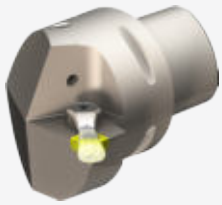

- Spannsystem: Die Wendeplatte wird mittels Schraubenklammer Typ S gespannt.
- Kühlsystem: Klemmhalter für positive Wendeplatten besitzen eine ausgerichtete Kühlmiteldüse.

- Clamping system: The insert is tightened via screw clamping Type S.
- Cooling system: Turning tools for positive inserts feature an adjusted coolant nozzle.

- Système de serrage : La plaquette est serrée par un serrage à vis de type S.
- Système d'arrosage : Les outils de tournage pour plaquettes positives sont équipés d'une buse d'arrosage dirigée.



- Spannsystem: Die Wendeplatte wird mittels Doppelklammer Typ D gespannt.
- Kühlsystem: Klemmhalter mit Doppelklammer verfügen über eine ausrichtbare Hochdruckkühl-düse.

- Clamping system: The insert is tightened via double-clamping Type D.
- Cooling system: Turning tools with double-clamping feature an adjustable high-pressure coolant nozzle.

- Système de serrage : La plaquette est serrée par un double serrage à vis de type D.
- Système d'arrosage : Les outils de tournage avec double serrage sont équipés d'une buse d'arrosage dirigée.

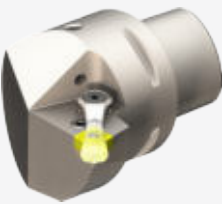

- Spannsystem: Die Wendeplatte wird mittels Kniehebelspannung Typ P gespannt.
- Kühlsystem: Klemmhalter mit Kniehebelspannung besitzen eine ausgerichtete Kühlmittel-düse.

- Clamping system: The insert is tightened via knuckle joint Type P.
- Cooling system: Turning tools with knuckle joint-clamping feature an adjusted coolant nozzle.

- Système de serrage : La plaquette est serrée par un joint articulé Type P.
- Système d'arrosage : Les outils de tournage avec joint articulé sont équipés d'une buse d'arrosage dirigée.

## Klemhalter

- für effiziente Drehbearbeitung
- optimale Kühlung durch ausgerichtete Kühldüse und Hochdruckkühldüse
- Klemhalter für Aussenbearbeitung können auch für die Innenbearbeitung verwendet werden unter Berücksichtigung des D1 min.

## Turning tool

- to turn efficiently
- optimal cooling by adjusted cooling nozzle and high pressure cooling nozzle
- Turning tools for exterior machining may also be used for interior machining, in consideration of D1 min.

## Outil de tournage

- pour des opérations de tournage efficaces
- arrosage optimal par buse d'arrosage dirigée et à haute pression
- Les outils de tournage destinés à l'usinage extérieur peuvent aussi être utilisés pour l'usinage intérieur, en tenant compte de D1 min.

### PWLN R/L 95°/80°

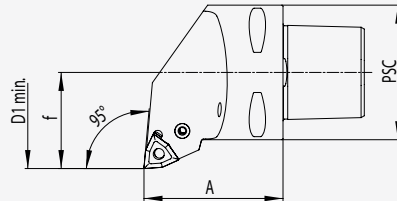

Bestell-Nr. / Order number/ Code	PSC	f	D1 min.	A	Wendeplatte/ Insert/ Plaquette	kg					
PS4.PWE.(R/L)LA.050-HP	40	27	50	50	WN .. 08 04 ..	0.42	WWE.ER2.101.004	WCD.ER4.101.017 (5.0 Nm)	WDF.ER3.101.000	WCD.ER1.101.000	CHPPCX.000.022
PS5.PWE.(R/L)LA.060-HP	50	35	65	60	WN .. 08 04 ..	0.76	WWE.ER2.101.004	WCD.ER4.101.017 (5.0 Nm)	WDF.ER3.101.000	WCD.ER1.101.000	CHPPCX.000.022
PS6.PWE.(R/L)LA.065-HP	63	45	80	65	WN .. 08 04 ..	1.37	WWE.ER2.101.004	WCD.ER4.101.017 (5.0 Nm)	WDF.ER3.101.000	WCD.ER1.101.000	CHPPCX.000.022

### SCLC R/L 95°/80°

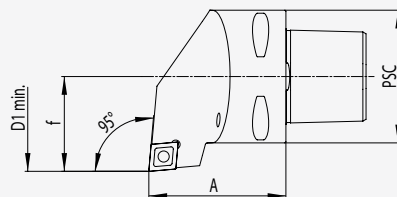

Bestell-Nr. / Order number/ Code	PSC	f	D1 min.	A	Wendeplatte/ Insert/ Plaquette	kg			
PS4.KCC.(R/L)LA.050-HP	40	27	50	50	CC .. 12 04 ..	0.37	WCC.ER1.001.000	WCC.ER2.001.010 (5.0 Nm)	CHPPCX.000.022
PS5.KCB.(R/L)LA.060-HP	50	35	65	60	CC .. 09 T3 ..	0.80	WCB.ER1.001.000	WCB.ER2.001.009 (3.0 Nm)	CHPPCX.000.022
PS5.KCC.(R/L)LA.060-HP	50	35	65	60	CC .. 12 04 ..	0.73	WCC.ER1.001.000	WCC.ER2.001.010 (5.0 Nm)	CHPPCX.000.022
PS6.KCB.(R/L)LA.065	63	45	80	65	CC .. 09 T3 ..	1.24	WCB.ER1.001.000	WCB.ER2.001.009 (3.0 Nm)	CHPPCX.000.022
PS6.KCC.(R/L)LA.065-HP	63	45	80	65	CC .. 12 04 ..	1.40	WCC.ER1.001.000	WCC.ER2.001.010 (5.0 Nm)	CHPPCX.000.022



Bestell-Nr. /  
Order number/  
Code

CHP.PCX.000.022

- Hochleistungskühlmittel Set beinhaltet:
  - HP Düse
  - O-Ring

- High performance coolant set included:
  - HP coolant nozzle
  - O-ring

- Kit d'arrosage haute performance comprend
  - Buse HP
  - O-Ring

**PCLN R/L 95°/80°**

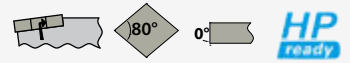
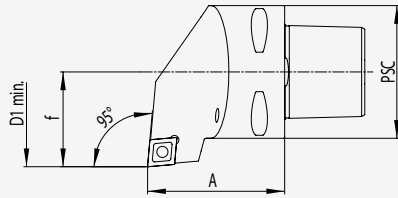

Bestell-Nr. / Order number/ Code	PSC	f	D1 min.	A	Wendeplatte/ Insert/ Plaquette	kg					
PS4.PCD.(R/L)LA.050-HP	40	27	50	50	CN ..12 04 ..	0.39	WCD.ER2.101.003	WCD.ER4.101.017 (5.0 Nm)	WCD.ER3.101.000	WCD.ER1.101.000	CHPPCX.000.022
PS5.PCD.(R/L)LA.060-HP	50	35	65	60	CN ..12 04 ..	0.70	WCD.ER2.101.003	WCD.ER4.101.017 (5.0 Nm)	WCD.ER3.101.000	WCD.ER1.101.000	CHPPCX.000.022
PS5.PCE.(R/L)LA.060	50	35	65	60	CN ..16 06 ..	0.70	WCE.ER2.101.004	WCE.ER4.101.004 (5.0 Nm)	WCE.ER3.101.000	WCE.ER1.101.000	
PS6.PCD.(R/L)LA.065-HP	63	45	80	65	CN ..12 04 ..	1.30	WCD.ER2.101.003	WCD.ER4.101.017 (5.0 Nm)	WCD.ER3.101.000	WCD.ER1.101.000	CHPPCX.000.022
PS6.PCE.(R/L)LA.065-HP	63	45	80	65	CN ..16 06 ..	1.30	WCE.ER2.101.004	WCE.ER4.101.004 (5.0 Nm)	WCE.ER3.101.000	WCE.ER1.101.000	CHPPCX.000.022

**SDUC R/L 93°/55°**

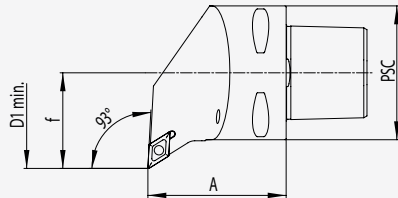

Bestell-Nr. / Order number/ Code	PSC	f	D1 min.	A	Wendeplatte/ Insert/ Plaquette	kg			
PS4.KDB.(R/L)UA.050-HP	40	27	50	50	DC ..11 T3 ..	0.39	WCB.ER1.001.000	WCB.ER2.001.009 (3.0 Nm)	CHPPCX.000.022
PS5.KDB.(R/L)UA.060-HP	50	35	65	60	DC ..11 T3 ..	0.70	WCB.ER1.001.000	WCB.ER2.001.009 (3.0 Nm)	CHPPCX.000.022
PS6.KDA.(R/L)UA.065	63	45	80	65	DC ..07 02 ..	1.30	WCA.ER1.001.000	WCA.ER2.001.006 (0.9 Nm)	
PS6.KDB.(R/L)UA.065-HP	63	45	80	65	DC ..11 T3 ..	1.30	WCB.ER1.001.000	WCB.ER2.001.009 (3.0 Nm)	CHPPCX.000.022

**PDUN R/L 93°/55°**

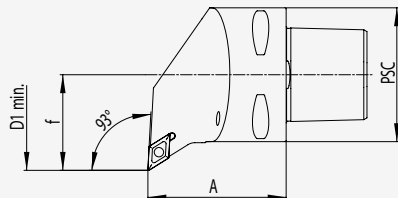

Bestell-Nr. / Order number/ Code	PSC	f	D1 min.	A	Wendeplatte/ Insert/ Plaquette	kg					
PS4.PDE.(R/L)UA.050-HP	40	27	50	50	DN ..11 04 ..	0.39					CHPPCX.000.022
PS4.PDF.(R/L)UA.050-HP	40	27	50	50	DN ..15 06 ..*	0.39	WDF.ER2.101.003	WCD.ER4.101.017 (5.0 Nm)	WDF.ER3.101.000	WCD.ER1.101.000	CHPPCX.000.022
PS5.PDF.(R/L)UA.060-HP	50	35	65	60	DN ..15 06 ..*	0.70	WDF.ER2.101.003	WCD.ER4.101.017 (5.0 Nm)	WDF.ER3.101.000	WCD.ER1.101.000	CHPPCX.000.022
PS6.PDF.(R/L)UA.065-HP	63	45	80	65	DN ..15 06 ..*	1.30	WDF.ER2.101.003	WCD.ER4.101.017 (5.0 Nm)	WDF.ER3.101.000	WCD.ER1.101.000	CHPPCX.000.022

\* DN .. 15 04 .. möglich mit Unterlegplatte WDF.ER2.101.004

\* DN .. 15 04 .. possible with tip pad WDF.ER2.101.004

\* DN .. 15 04 .. possible avec plateau de support WDF.ER2.101.004



**SDJC R/L 55°/93°**

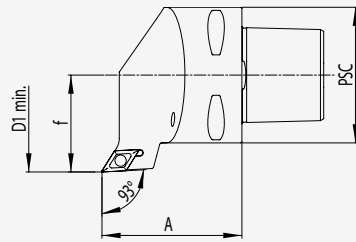

Bestell-Nr. / Order number/ Code	PSC	f	D1 min.	A	Wendeplatte/ Insert/ Plaquette	kg			
PS4.KDB.(R/L)JA.050-HP	40	27	50	50	DC...11 T3..	0.39	WCB.ER1.001.000	WCB.ER2.001.009 (3.0 Nm)	CHPPCX.000.022
PS5.KDB.(R/L)JA.060-HP	50	35	60	60	DC...11 T3..	0.70	WCB.ER1.001.000	WCB.ER2.001.009 (3.0 Nm)	CHPPCX.000.022
PS6.KDB.(R/L)JA.065-HP	63	45	80	65	DC...11 T3..	1.30	WCB.ER1.001.000	WCB.ER2.001.009 (3.0 Nm)	CHPPCX.000.022

**PDJN R/L 55°/93°**

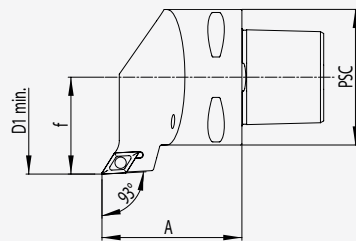

Bestell-Nr. / Order number/ Code	PSC	f	D1 min.	A	Wendeplatte/ Insert/ Plaquette	kg				
PS4.PDE.(R/L)JA.050-HP	40	27	-	50	DN...11 04..	0.39				CHPPCX.000.022
PS4.PDF.(R/L)JA.050-HP	40	27	-	50	DN...15 06..*	0.39	WDF.ER2.101.003	WCD.ER4.101.017 (5.0 Nm)	WDF.ER3.101.000	WCD.ER1.101.000
PS5.PDF.(R/L)JA.060-HP	50	35	-	60	DN...15 06..*	0.70	WDF.ER2.101.003	WCD.ER4.101.017 (5.0 Nm)	WDF.ER3.101.000	WCD.ER1.101.000
PS6.PDF.(R/L)JA.065-HP	63	45	-	65	DN...15 06..*	1.30	WDF.ER2.101.003	WCD.ER4.101.017 (5.0 Nm)	WDF.ER3.101.000	WCD.ER1.101.000

\* DN...15 04.. möglich mit Unterlegplatte WDF.ER2.101.004

\* DN...15 04.. possible with tip pad WDF.ER2.101.004

\* DN...15 04.. possible avec plateau de support WDF.ER2.101.004

**SDHC R/L 107.5°/55°**

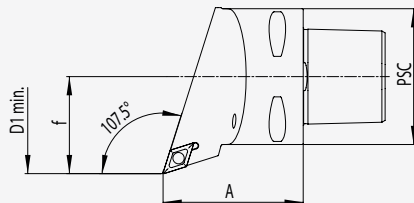

Bestell-Nr. / Order number/ Code	PSC	f	D1 min.	A	Wendeplatte/ Insert/ Plaquette	kg			
PS4.KDB.(R/L)HA.050-HP	40	27	50	50	DC...11 T3..	0.39	WCB.ER1.001.000	WCB.ER2.001.009 (3.0 Nm)	CHPPCX.000.022
PS5.KDB.(R/L)HA.060-HP	50	35	60	60	DC...11 T3..	0.70	WCB.ER1.001.000	WCB.ER2.001.009 (3.0 Nm)	CHPPCX.000.022
PS6.KDB.(R/L)HA.065-HP	63	45	80	65	DC...11 T3..	1.30	WCB.ER1.001.000	WCB.ER2.001.009 (3.0 Nm)	CHPPCX.000.022

**PDHN R/L 107.5°/55°**

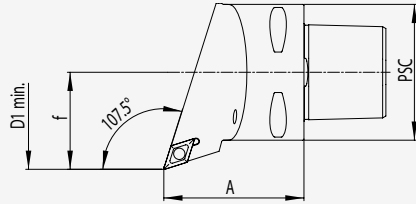

Bestell-Nr. / Order number/ Code	PSC	f	D1 min.	A	Wendeplatte/ Insert/ Plaquette	kg					
PS4.PDF.(R/L)HA.050-HP	40	27	50	50	DN .. 15 06 .. *	0.39	WDF.ER2.101.003	WCD.ER4.101.017 (5.0 Nm)	WDF.ER3.101.000	WCD.ER1.101.000	CHPPCX.000.022
PS5.PDF.(R/L)HA.060-HP	50	35	60	60	DN .. 15 06 .. *	0.70	WDF.ER2.101.003	WCD.ER4.101.017 (5.0 Nm)	WDF.ER3.101.000	WCD.ER1.101.000	CHPPCX.000.022
PS6.PDF.(R/L)HA.065-HP	63	45	80	65	DN .. 15 06 .. *	1.30	WDF.ER2.101.003	WCD.ER4.101.017 (5.0 Nm)	WDF.ER3.101.000	WCD.ER1.101.000	CHPPCX.000.022

\* DN .. 15 04 .. möglich mit Unterlegplatte  
WDF.ER2.101.004

\* DN .. 15 04 .. possible with tip pad  
WDF.ER2.101.004

\* DN .. 15 04 .. possible avec plateau de  
support WDF.ER2.101.004

**SVUB R/L 93°/35°**

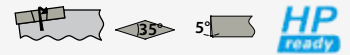
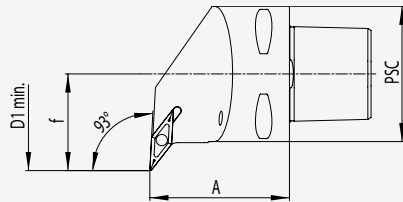

Bestell-Nr. / Order number/ Code	PSC	f	D1 min.	A	Wendeplatte/ Insert/ Plaquette	kg			
PS4.KVF.(R/L) UA.050	40	27	50	50	VB .. 16 04 ..	0.39	WCB.ER1.001.000	WCB.ER2.001.009 (3.0 Nm)	WCB.ER1.001.000
PS5.KVF.(R/L) UA.060	50	35	65	60	VB .. 16 04 ..	0.70	WCB.ER1.001.000	WCB.ER2.001.009 (3.0 Nm)	WCB.ER1.001.000
PS6.KVF.(R/L) UA.065	63	45	80	65	VB .. 16 04 ..	1.30	WCB.ER1.001.000	WCB.ER2.001.009 (3.0 Nm)	WCB.ER1.001.000

**SVUC R/L 93°/35°**

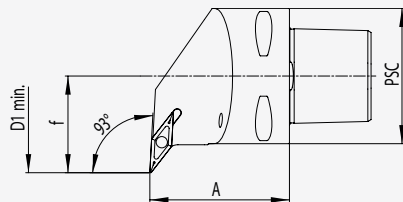

Bestell-Nr. / Order number/ Code	PSC	f	D1 min.	A	Wendeplatte/ Insert/ Plaquette	kg			
PS4.KVB.(R/L) UA.050	40	27	50	50	VC .. 16 04 ..	0.39	WCB.ER1.001.000	WCA.ER2.001.006 (0.9 Nm)	WCB.ER2.001.009 (3.0 Nm)
PS5.KVA.(R/L) UA.060	50	35	65	60	VC .. 11 03 ..	0.70	WCA.ER1.001.000	WCA.ER2.001.006 (0.9 Nm)	WCB.ER2.001.009 (3.0 Nm)
PS5.KVB.(R/L) UA.060	50	35	65	60	VC .. 16 04 ..	0.70	WCB.ER1.001.000	WCB.ER2.001.009 (3.0 Nm)	WCB.ER2.001.009 (3.0 Nm)
PS6.KVB.(R/L) UA.065	63	45	80	65	VC .. 16 04 ..	1.30	WCB.ER1.001.000	WCB.ER2.001.009 (3.0 Nm)	WCB.ER2.001.009 (3.0 Nm)

DVUN R/L 93°/35°

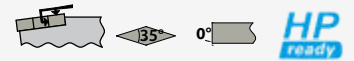
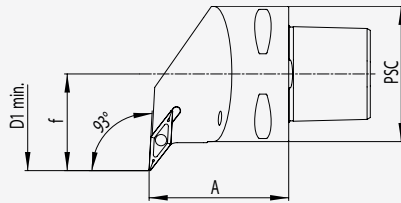

Bestell-Nr. / Order number/ Code	PSC	f	D1 min.	A	Wendeplatte/ Insert/ Plaquette	kg					
PS4.KVD.(R/L) UA.050	40	27	50	50	VN..16 04..	0.39	WVD.ER2.101.003	WCC.ER4.103.032 (10 Nm)	WCC.ER4.103.032 (10 Nm)	WCC.ER5.102.012	WCC.ER3.102.024
PS5.KVD.(R/L) UA.060	50	35	65	60	VN..16 04..	0.70	WVD.ER2.101.003	WCC.ER4.103.032 (10 Nm)	WCC.ER4.103.032 (10 Nm)	WCC.ER5.102.012	WCC.ER3.102.024
PS6.KVD.(R/L) UA.065	63	45	80	65	VN..16 04..	1.30	WVD.ER2.101.003	WCC.ER4.103.032 (10 Nm)	WCC.ER4.103.032 (10 Nm)	WCC.ER5.102.012	WCC.ER3.102.024

SVJB R/L 35°/93°

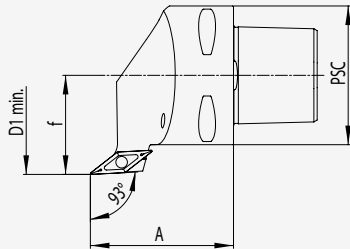

Bestell-Nr. / Order number/ Code	PSC	f	D1 min.	A	Wendeplatte/ Insert/ Plaquette	kg			
PS4.KVF.(R/L) JA.050	40	27	50	50	VB..16 04..	0.39	WCB.ER1.001.000	WCB.ER2.001.009 (3.0 Nm)	WCB.ER2.001.009 (3.0 Nm)
PS5.KVF.(R/L) JA.060	50	35	65	60	VB..16 04..	0.70	WCB.ER1.001.000	WCB.ER2.001.009 (3.0 Nm)	WCB.ER2.001.009 (3.0 Nm)
PS6.KVF.(R/L) JA.065	63	45	80	65	VB..16 04..	1.30	WCB.ER1.001.000	WCB.ER2.001.009 (3.0 Nm)	WCB.ER2.001.009 (3.0 Nm)

SVJC R/L 35°/93°

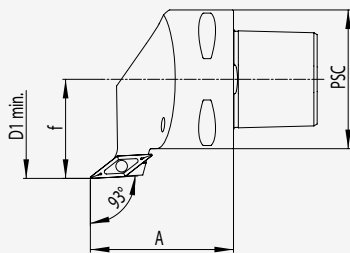

Bestell-Nr. / Order number/ Code	PSC	f	D1 min.	A	Wendeplatte/ Insert/ Plaquette	kg			
PS4.KVA.(R/L) JA.050	40	27	50	50	VC..11 03..	0.39	WCA.ER1.001.000	WCA.ER2.001.006 (0.9 Nm)	WCB.ER2.001.009 (3.0 Nm)
PS5.KVB.(R/L) JA.060	50	35	65	60	VC..16 04..	0.70	WCB.ER1.001.000	WCB.ER2.001.009 (3.0 Nm)	WCB.ER2.001.009 (3.0 Nm)
PS6.KVB.(R/L) JA.065	63	45	80	65	VC..16 04..	1.30	WCB.ER1.001.000	WCB.ER2.001.009 (3.0 Nm)	WCB.ER2.001.009 (3.0 Nm)

DVJN R/L 35°/93°

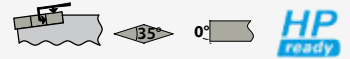
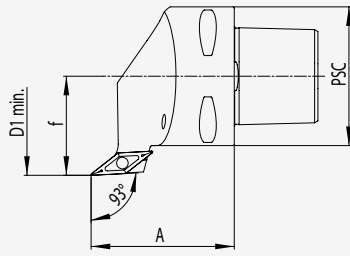

Bestell-Nr. / Order number/ Code	PSC	f	D1 min.	A	Wendeplatte/ Insert/ Plaquette	kg					
PS4.KVD.(R/L) JA.050	40	27	50	50	VN ..16 04 ..	0.39	WVD.ER2.101.003	WCC.ER4.103.032 (10 Nm)	WCC.ER4.103.032 (10 Nm)	WCC.ER5.102.012	WCC.ER3.102.024
PS5.KVD.(R/L) JA.060	50	35	65	60	VN ..16 04 ..	0.70	WVD.ER2.101.003	WCC.ER4.103.032 (10 Nm)	WCC.ER4.103.032 (10 Nm)	WCC.ER5.102.012	WCC.ER3.102.024
PS6.KVD.(R/L) JA.065	63	45	80	65	VN ..16 04 ..	1.30	WVD.ER2.101.003	WCC.ER4.103.032 (10 Nm)	WCC.ER4.103.032 (10 Nm)	WCC.ER5.102.012	WCC.ER3.102.024

SVPB R/L 117.5°/35°

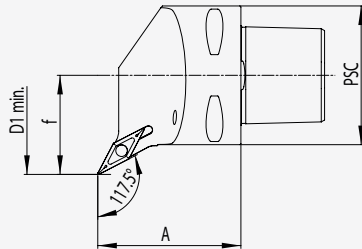

Bestell-Nr. / Order number/ Code	PSC	f	D1 min.	A	Wendeplatte/ Insert/ Plaquette	kg			
PS4.KVF.(R/L)PA.050	40	27	50	50	VB ..16 04 ..	0.39	WCB.ER1.001.000	WCB.ER2.001.009 (3.0 Nm)	WCB.ER2.001.009 (3.0 Nm)
PS5.KVF.(R/L)PA.060	50	35	65	60	VB ..16 04 ..	0.70	WCB.ER1.001.000	WCB.ER2.001.009 (3.0 Nm)	WCB.ER2.001.009 (3.0 Nm)
PS6.KVF.(R/L)PA.065	63	45	80	65	VB ..16 04 ..	1.30	WCB.ER1.001.000	WCB.ER2.001.009 (3.0 Nm)	WCB.ER2.001.009 (3.0 Nm)

SVPC R/L 117.5°/35°

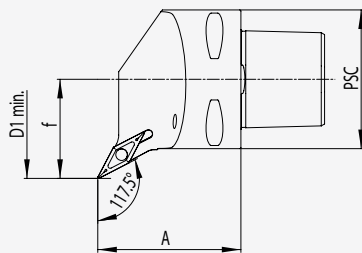

Bestell-Nr. / Order number/ Code	PSC	f	D1 min.	A	Wendeplatte/ Insert/ Plaquette	kg				
PS4.KVA.(R/L)PA.050	40	27	50	50	VC ..11 03 ..	0.39	WCA.ER1.001.000	WCA.ER2.001.006 (0.9 Nm)	WCB.ER2.001.009 (3.0 Nm)	
PS4.KVB.(R/L)PA.050	40	27	50	50	VC ..16 04 ..	0.39	WCB.ER1.001.000	WCB.ER2.001.009 (3.0 Nm)	WCB.ER2.001.009 (3.0 Nm)	CHPPCX.000.022
PS5.KVB.(R/L)PA.060-HP	50	35	65	60	VC ..16 04 ..	0.70	WCB.ER1.001.000	WCB.ER2.001.009 (3.0 Nm)	WCB.ER2.001.009 (3.0 Nm)	CHPPCX.000.022
PS6.KVB.(R/L)PA.065-HP	63	45	80	65	VC ..16 04 ..	1.32	WCB.ER1.001.000	WCB.ER2.001.009 (3.0 Nm)	WCB.ER2.001.009 (3.0 Nm)	CHPPCX.000.022

DVPN R/L 117.5°/35°

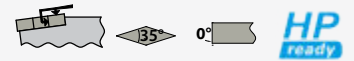
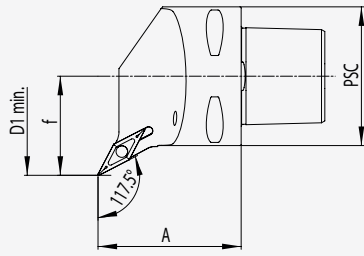

Bestell-Nr. / Order number/ Code	PSC	f	D1 min.	A	Wendeplatte/ Insert/ Plaquette	kg					
PS4.KVD.(R/L)PA.050	40	27	50	50	VN..16 04..	0.39	WVD.ER2.101.003	WCC.ER4.103.032 (10 Nm)	WCC.ER4.103.032 (10 Nm)	WCC.ER5.102.012	WCC.ER3.102.024
PS5.KVD.(R/L)PA.060	50	35	65	60	VN..16 04..	0.70	WVD.ER2.101.003	WCC.ER4.103.032 (10 Nm)	WCC.ER4.103.032 (10 Nm)	WCC.ER5.102.012	WCC.ER3.102.024
PS6.KVD.(R/L)PA.065	63	45	80	65	VN..16 04..	1.30	WVD.ER2.101.003	WCC.ER4.103.032 (10 Nm)	WCC.ER4.103.032 (10 Nm)	WCC.ER5.102.012	WCC.ER3.102.024

SSBC R/L 90°/75°

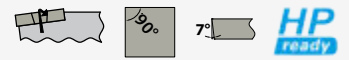
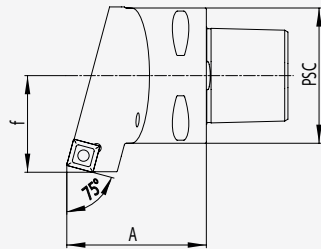
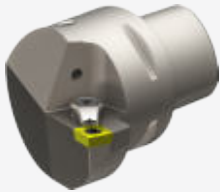

Bestell-Nr. / Order number/ Code	PSC	f	D1 min.	A	Wendeplatte/ Insert/ Plaquette	kg				
PS4.KSB.(R/L)BA.050	40	27	-	50	SC..12 04..	0.39	WCC.ER1.001.000	WCC.ER2.001.010 (5.0 Nm)	WCB.ER1.001.000	WCC.ER2.001.010 (5.0 Nm)
PS5.KSB.(R/L)BA.060	50	35	-	60	SC..12 04..	0.70	WCB.ER1.001.000	WCB.ER2.001.009 (3.0 Nm)	WCB.ER1.001.000	WCC.ER2.001.010 (5.0 Nm)
PS6.KSB.(R/L)BA.065	63	45	-	65	SC..12 04..	1.32	WCC.ER1.001.000	WCC.ER2.001.010 (5.0 Nm)	WCB.ER1.001.000	WCC.ER2.001.010 (5.0 Nm)

PSBN R/L 90°/75°

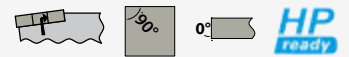
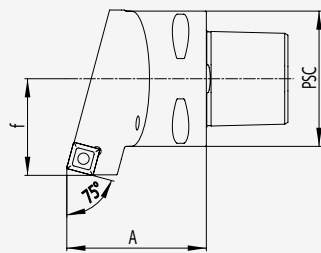

Bestell-Nr. / Order number/ Code	PSC	f	D1 min.	A	Wendeplatte/ Insert/ Plaquette	kg					
PS4.PSD.(R/L)BA.050	40	27	-	50	SN..12 04..	0.39	WSD.ER2.101.003	WCD.ER4.101.017 (5.0 Nm)	WCD.ER3.101.000	WCD.ER1.101.000	WCD.ER4.101.017 (5.0 Nm)
PS5.PSD.(R/L)BA.060	50	35	-	60	SN..12 04..	0.70	WSD.ER2.101.003	WCD.ER4.101.017 (5.0 Nm)	WCD.ER3.101.000	WCD.ER1.101.000	WCD.ER4.101.017 (5.0 Nm)
PS6.PSD.(R/L)BA.065	63	45	-	65	SN..12 04..	1.32	WSD.ER2.101.003	WCD.ER4.101.017 (5.0 Nm)	WCD.ER3.101.000	WCD.ER1.101.000	WCD.ER4.101.017 (5.0 Nm)

**SSSC R/L 90°/45°**

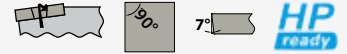
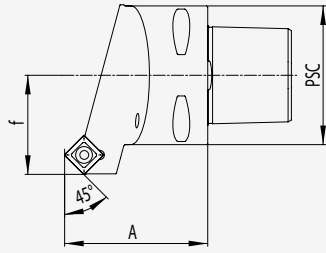

Bestell-Nr. / Order number/ Code	PSC	f	D1 min.	A	Wendeplatte/ Insert/ Plaquette	kg			
PS4.KSA.(R/L)SA.050	40	27	-	50	SC..09T3..	0.39	WCB.ER1.001.000	WCB.ER2.001.009 (3.0 Nm)	
PS4.KSB.(R/L)SA.050	40	27	-	50	SC..12 04..	0.39	WCC.ER1.001.000	WCC.ER2.001.010 (5.0 Nm)	
PS5.KSB.(R/L)SA.060	50	35	-	60	SC..12 04..	0.70	WCB.ER1.001.000	WCB.ER2.001.009 (3.0 Nm)	
PS6.KSB.(R/L)SA.065	63	45	-	65	SC..12 04..	1.32	WCC.ER1.001.000	WCC.ER2.001.010 (5.0 Nm)	

**PSNN R/L 90°/45°**

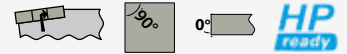
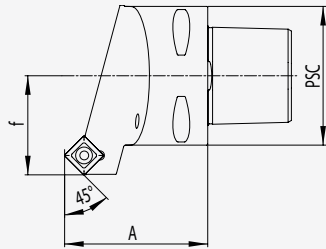

Bestell-Nr. / Order number/ Code	PSC	f	D1 min.	A	Wendeplatte/ Insert/ Plaquette	kg					
PS4.PSD.(R/L)SA.050	40	27	-	50	SN..12 04..	0.39	WSD.ER2.101.003	WCD.ER4.101.017 (5.0 Nm)	WCD.ER3.101.000	WCD.ER1.101.000	
PS5.PSD.(R/L)SA.060	50	35	-	60	SN..12 04..	0.70	WSD.ER2.101.003	WCD.ER4.101.017 (5.0 Nm)	WCD.ER3.101.000	WCD.ER1.101.000	
PS6.PSD.(R/L)SA.065	63	45	-	65	SN..12 04..	1.22	WSD.ER2.101.003	WCD.ER4.101.017 (5.0 Nm)	WCD.ER3.101.000	WCD.ER1.101.000	

## SCMC N 50°/80°/50°

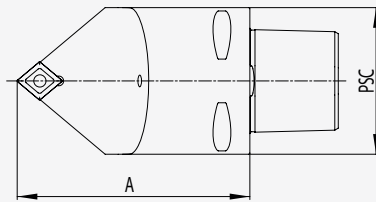

Bestell-Nr. / Order number/ Code	PSC	A	Wendeplatte/ Insert/ Plaquette	kg			
PS5.KCC.NMA.100	50	100	CC..12 04..	1.28	WCC.ER1.001.000	WCC.ER2.001.010 (5.0 Nm)	
PS6.KCC.NMA.100-HP	63	100	CC..12 04..	1.75	WCC.ER1.001.000	WCC.ER2.001.010 (5.0 Nm)	CHPPCX.000.022
PS6.KCC.NMA.130-HP	63	130	CC..12 04..	2.48	WCC.ER1.001.000	WCC.ER2.001.010 (5.0 Nm)	CHPPCX.000.022

## PCMN N 50°/80°/50°

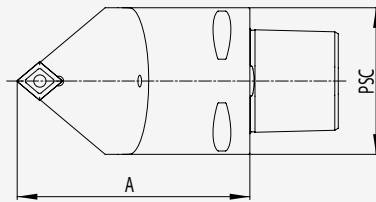

Bestell-Nr. / Order number/ Code	PSC	A	Wendeplatte/ Insert/ Plaquette	kg					
PS5.PCD.NMA.060-HP	50	60	CN..12 04..	0.80	WCD.ER2.101.003	WCD.ER4.101.017 (5.0 Nm)	WCD.ER3.101.000	WCD.ER1.101.000	CHPPCX.000.022
PS6.PCD.NMA.100-HP	63	100	CN..12 04..	1.84	WCD.ER2.101.003	WCD.ER4.101.017 (5.0 Nm)	WCD.ER3.101.000	WCD.ER1.101.000	CHPPCX.000.022
PS6.PCD.NMA.130-HP	63	130	CN..12 04..	2.51	WCD.ER2.101.003	WCD.ER4.101.017 (5.0 Nm)	WCD.ER3.101.000	WCD.ER1.101.000	CHPPCX.000.022
PS6.PCE.NMA.100-HP	63	100	CN..16 06..	1.83	WCE.ER2.101.004	WCE.ER4.101.004 (5.0 Nm)	WCE.ER3.101.000	WCE.ER1.101.000	CHPPCX.000.022
PS6.PCE.NMA.130-HP	63	130	CN..16 06..	2.56	WCE.ER2.101.004	WCE.ER4.101.004 (5.0 Nm)	WCE.ER3.101.000	WCE.ER1.101.000	CHPPCX.000.022



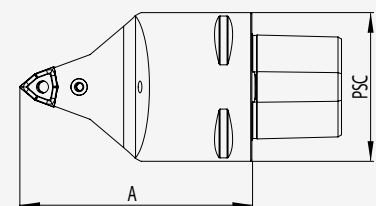

## PWMC N 50°/80°/50°

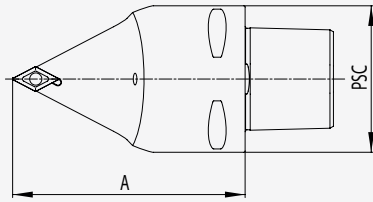

Bestell-Nr. / Order number/ Code	PSC	A	Wendeplatte/ Insert/ Plaquette	kg					
PS6.PWE.NMA.100-HP	63	100	WN..08 04..	1.58	WWE.ER2.101.004	WCD.ER4.101.017 (5.0 Nm)	WDF.ER3.101.000	WCD.ER1.101.000	CHPPCX.000.022
PS6.PWE.NMA.130-HP	63	130	WN..08 04..	2.30	WWE.ER2.101.004	WCD.ER4.101.017 (5.0 Nm)	WDF.ER3.101.000	WCD.ER1.101.000	CHPPCX.000.022





## SDNC N 62.5°/55°/62.5°

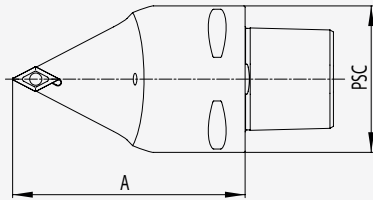

Bestell-Nr. / Order number/ Code	PSC	A	Wendeplatte/ Insert/ Plaquette	kg					
PS5.KDB.NNA.100	50	60	DC..11 T3..	0.81	WCB.ER1.001.000	WCB.ER2.001.009 (3.0 Nm)			
PS6.KDB.NNA.100-HP	63	100	DC..11 T3..	1.63	WCB.ER1.001.000	WCB.ER2.001.009 (3.0 Nm)	CHPPCX.000.022		
PS6.KDB.NNA.130-HP	63	130	DC..11 T3..	2.35	WCB.ER1.001.000	WCB.ER2.001.009 (3.0 Nm)	CHPPCX.000.022		

## PDNN N 62.5°/55°/62.5°



Bestell-Nr. / Order number/ Code	PSC	A	Wendeplatte/ Insert/ Plaquette	kg					
PS6.PDF.NNA.100-HP	63	100	DN..15 06..*	1.74	WDF.ER2.101.003	WCC.ER4.103.032 (10 Nm)	WCC.ER3.102.024	WCC.ER5.102.012	CHPPCX.000.022
PS6.PDF.NNA.130-HP	63	130	DN..15 06..*	2.43	WDF.ER2.101.003	WCC.ER4.103.032 (10 Nm)	WCC.ER3.102.024	WCC.ER5.102.012	CHPPCX.000.022

\* DN..15 04.. möglich mit Unterlegplatte  
WDF.ER2.101.004

\* DN..15 04.. possible with tip pad  
WDF.ER2.101.004

\* DN..15 04.. possible avec plateau de  
support WDF.ER2.101.004



## SVVB N 72.5°/35°/72.5°

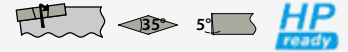
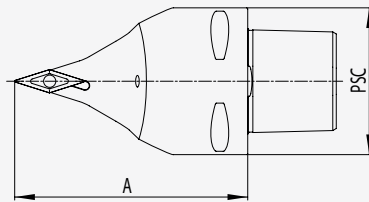

Bestell-Nr. / Order number/ Code	PSC	A	Wendeplatte/ Insert/ Plaquette	kg			
PS4.KVF.NVA.080	40	80	VB..16 04..	0.50	WCB.ER1.001.000	WCB.ER2.001.009 (3.0 Nm)	
PS5.KVF.NVA.060	50	60	VB..16 04..	1.62	WCB.ER1.001.000	WCB.ER2.001.009 (3.0 Nm)	
PS6.KVF.NVA.100-HP	63	100	VB..16 04..	1.52	WCB.ER1.001.000	WCB.ER2.001.009 (3.0 Nm)	CHPPCX.000.022
PS6.KVF.NVA.130-HP	63	130	VB..16 04..	2.24	WCB.ER1.001.000	WCB.ER2.001.009 (3.0 Nm)	CHPPCX.000.022

## SVVC N 72.5°/35°/72.5°

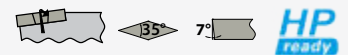
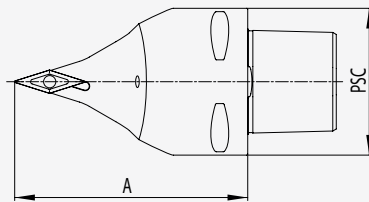

Bestell-Nr. / Order number/ Code	PSC	A	Wendeplatte/ Insert/ Plaquette	kg			
PS6.KVB.NVA.100-HP	63	100	VC..16 04..	1.50	WCB.ER1.001.000	WCB.ER2.001.009 (3.0 Nm)	CHPPCX.000.022
PS6.KVB.NVA.130-HP	63	130	VC..16 04..	2.22	WCB.ER1.001.000	WCB.ER2.001.009 (3.0 Nm)	CHPPCX.000.022

## DVVN N 72.5°/35°/72.5°

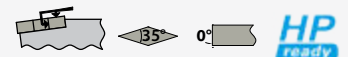
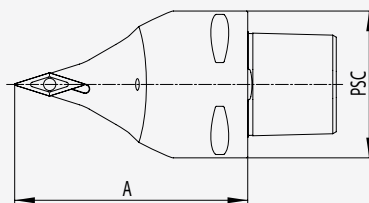

Bestell-Nr. / Order number/ Code	PSC	A	Wendeplatte/ Insert/ Plaquette	kg					
PS6.KVD.NVA.100	63	100	VN..16 04..	1.50	WVD.ER2.101.003	WCC.ER4.103.032 (10 Nm)	WCC.ER5.102.012	WCC.ER3.102.029	WCC.ER3.102.024
PS6.KVD.NVA.130	63	130	VN..16 04..	2.22	WVD.ER2.101.003	WCC.ER4.103.032 (10 Nm)	WCC.ER5.102.012	WCC.ER3.102.029	WCC.ER3.102.024

**PDMN L 48° (93°)/55°**

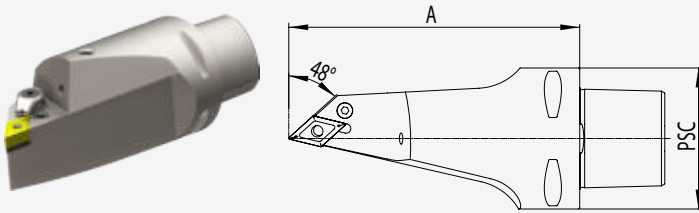

Bestell-Nr. / Order number/ Code	PSC	A	Wendeplatte/ Insert/ Plaquette	kg					
PS6.PDF.NXA.130-HP	63	130	DN .. 15 06 .. *	2.43	WDF.ER2.101.003	WCD.ER4.101.017 (5.0 Nm)	WDF.ER3.101.000	WCD.ER1.101.000	CHPPCX.000.022

\* DN .. 15 04 .. möglich mit Unterlegplatte  
WDF.ER2.101.004

\* DN .. 15 04 .. possible with tip pad  
WDF.ER2.101.004

\* DN .. 15 04 .. possible avec plateau de  
support WDF.ER2.101.004

**SVMB L 50° (95°)/35°**

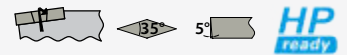
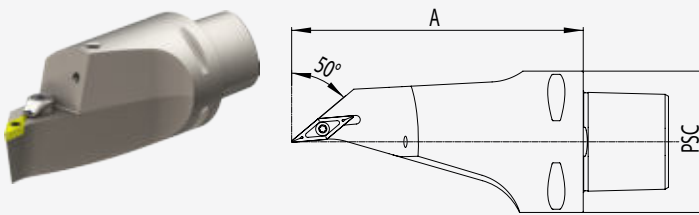

Bestell-Nr. / Order number/ Code	PSC	A	Wendeplatte/ Insert/ Plaquette	kg			
PS6.KVF.NMA.130-HP	63	130	VB .. 16 04 ..	1.95	WCB.ER1.001.000	WCB.ER2.001.009 (3.0 Nm)	CHPPCX.000.022

**SVMC L 50° (95°)/35°**

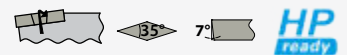
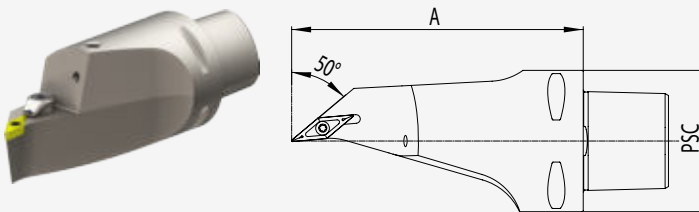

Bestell-Nr. / Order number/ Code	PSC	A	Wendeplatte/ Insert/ Plaquette	kg			
PS6.KVB.NMA.130-HP	63	130	VC .. 16 04 ..	1.93	WCB.ER1.001.000	WCB.ER2.001.009 (3.0 Nm)	CHPPCX.000.022

**DVMN L 50° (95°)/35°**

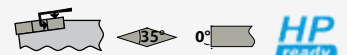
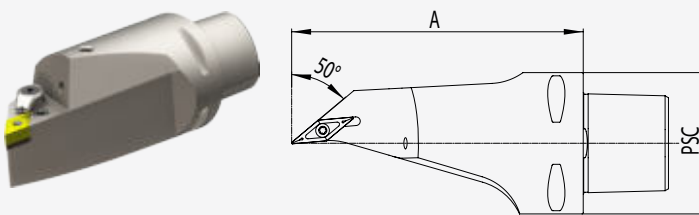

Bestell-Nr. / Order number/ Code	PSC	A	Wendeplatte/ Insert/ Plaquette	kg					
PS6.KVD.NMA.130	63	100	VN .. 16 04 ..	1.89	WVD.ER2.101.003	WCC.ER4.103.032 (10 Nm)	WCC.ER5.102.012	WCC.ER3.102.029	WCC.ER3.102.024

**T DCM 50° (95°) / DDM 48° (93°)**

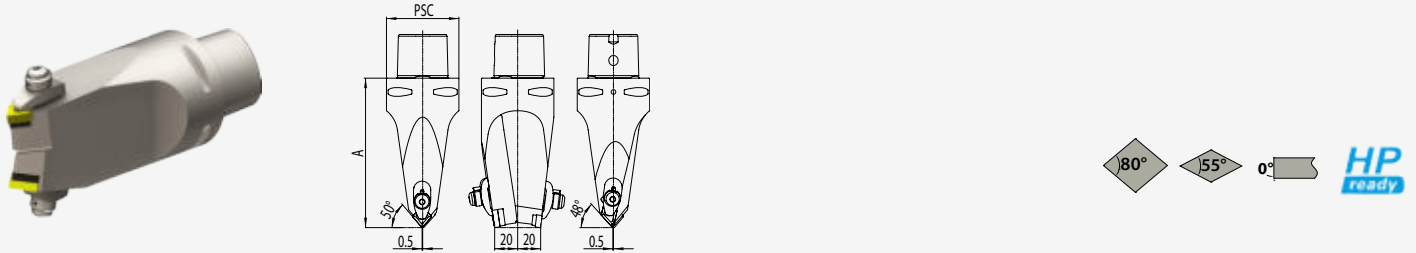

Bestell-Nr. / Order number/ Code	PSC	A	Wendeplatte/ Insert/ Plaquette	kg					
PS6.KCD.NXD.130	63	100	DN .. 15 06 .. * CN .. 12 04 ..	2,14	WDF.ER2.101.003 WCD.ER2.101.003	WCC.ER4.103.032 (10 Nm)	WCC.ER5.102.012	WCC.ER3.102.029	WCC.ER3.102.024 WCC.ER3.102.024

\* DN .. 15 04 .. möglich mit Unterlegplatte WDF.ER2.101.004

\* DN .. 15 04 .. possible with tip pad WDF.ER2.101.004

\* DN .. 15 04 .. possible avec plateau de support WDF.ER2.101.004

**T DCM 50° (95°) / SDM 48° (93°)**

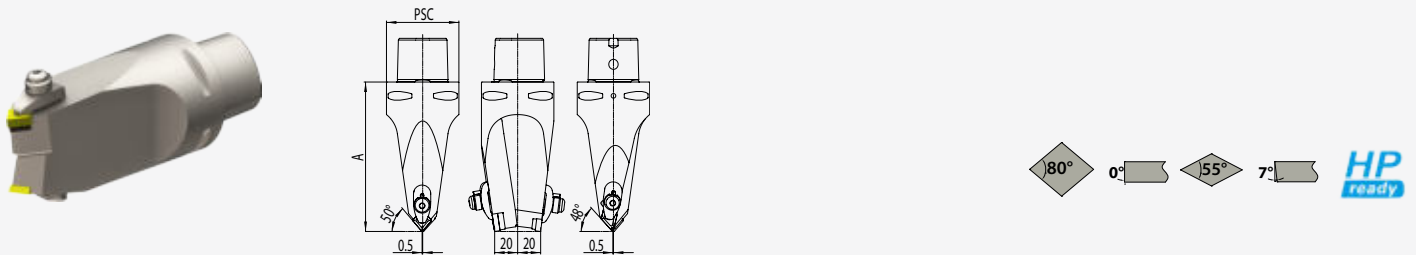

Bestell-Nr. / Order number/ Code	PSC	A	Wendeplatte/ Insert/ Plaquette	kg					
PS6.KCD.NYD.130	63	100	DC .. 11 T3 .. CN .. 12 04 ..	2,14	WCD.ER2.101.003	WCB.ER2.001.009 WCC.ER4.103.032	WCC.ER5.102.012	WCC.ER3.102.029	WCC.ER3.102.024

**T DDM 48° (93°) / SVM 50° (95°)**

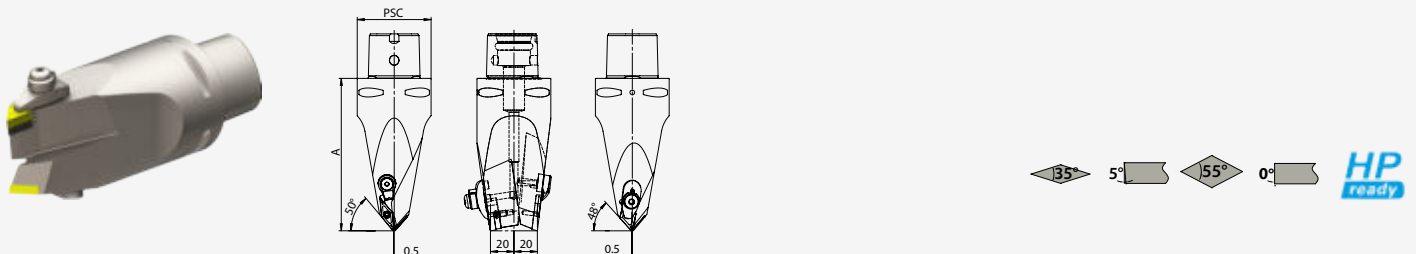

Bestell-Nr. / Order number/ Code	PSC	A	Wendeplatte/ Insert/ Plaquette	kg					
PS6.KDF.NXD.130	63	100	DN .. 15 06 .. * VB .. 16 04 ..	2,14	WDF.ER2.101.003	WCC.ER4.103.032 WCB.ER2.001.009	WCC.ER5.102.012	WCC.ER3.102.029	WCC.ER3.102.024

**T SVM 50° (95°) / DWM 50° (95°)**

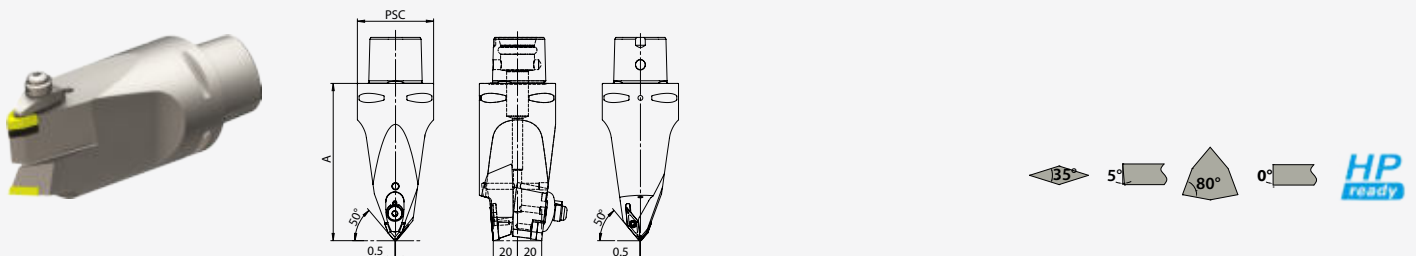

Bestell-Nr. / Order number/ Code	PSC	A	Wendeplatte/ Insert/ Plaquette	kg					
PS6.KWE.NXD.130	63	100	WN .. 08 04 .. VB .. 16 04 ..	2,14	WDF.ER2.101.003	WCC.ER4.103.032 WCB.ER2.001.009	WCC.ER5.102.012	WCC.ER3.102.029	WCC.ER3.102.024

## Aussengewinde radial

## External thread radial

## Filet extérieur radial

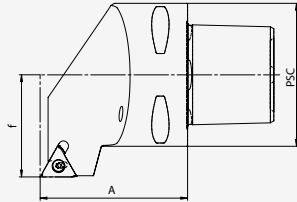

Bestell-Nr. / Order number/ Code	PSC	f	D1 min.	A	R/L	Wendeplatte/ Insert/ Plaquette	kg				
PS4.KGB.RGR.050	40	27	-	50	R	16 ER	0.42	WGB.ER1.001.000	WGB.ER2.001.012 (2.0 Nm)	WGB.ER2.102.003	WGB.ER3.001.007 (2.0 Nm)
PS4.KGB.LGR.050	40	27	-	50	L	16 EL	0.42	WGB.ER1.001.000	WGB.ER2.001.012 (2.0 Nm)	WGB.ER2.101.003	WGB.ER3.001.007 (2.0 Nm)
PS5.KGB.RGR.060	50	35	-	60	R	16 ER	0.74	WGB.ER1.001.000	WGB.ER2.001.012 (2.0 Nm)	WGB.ER2.102.003	WGB.ER3.001.007 (2.0 Nm)
PS5.KGB.LGR.060	50	35	-	60	L	16 EL	0.74	WGB.ER1.001.000	WGB.ER2.001.012 (2.0 Nm)	WGB.ER2.101.003	WGB.ER3.001.007 (2.0 Nm)
PS6.KGB.RGR.065	63	45	-	65	R	16 ER	1.28	WGB.ER1.001.000	WGB.ER2.001.012 (2.0 Nm)	WGB.ER2.102.003	WGB.ER3.001.007 (2.0 Nm)
PS6.KGB.LGR.065	63	45	-	65	L	16 EL	1.28	WGB.ER1.001.000	WGB.ER2.001.012 (2.0 Nm)	WGB.ER2.101.003	WGB.ER3.001.007 (2.0 Nm)

## Aussengewinde axial

## External thread axial

## Filet extérieur axial

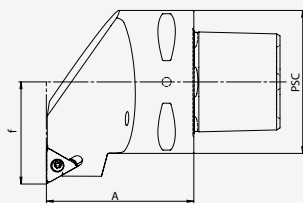

Bestell-Nr. / Order number/ Code	PSC	f	D1 min.	A	R/L	Wendeplatte/ Insert/ Plaquette	kg				
PS4.KGB.RGA.050	40	27	-	50	R	16 EL	0.42	WGB.ER1.001.000	WGB.ER2.001.012 (2.0 Nm)	WGB.ER2.102.003	WGB.ER3.001.007 (2.0 Nm)
PS4.KGB.LGA.050	40	27	-	50	L	16 ER	0.42	WGB.ER1.001.000	WGB.ER2.001.012 (2.0 Nm)	WGB.ER2.101.003	WGB.ER3.001.007 (2.0 Nm)
PS5.KGB.RGA.060	50	35	-	60	R	16 EL	0.74	WGB.ER1.001.000	WGB.ER2.001.012 (2.0 Nm)	WGB.ER2.102.003	WGB.ER3.001.007 (2.0 Nm)
PS5.KGB.LGA.060	50	35	-	60	L	16 ER	0.74	WGB.ER1.001.000	WGB.ER2.001.012 (2.0 Nm)	WGB.ER2.101.003	WGB.ER3.001.007 (2.0 Nm)
PS6.KGB.RGA.065	63	45	-	65	R	16 EL	1.36	WGB.ER1.001.000	WGB.ER2.001.012 (2.0 Nm)	WGB.ER2.102.003	WGB.ER3.001.007 (2.0 Nm)
PS6.KGB.LGA.065	63	45	-	65	L	16 ER	1.36	WGB.ER1.001.000	WGB.ER2.001.012 (2.0 Nm)	WGB.ER2.101.003	WGB.ER3.001.007 (2.0 Nm)

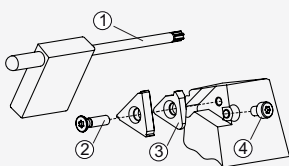

Für Gewindehalter For thread tool	Typ/ Type	Bestell-Nr. / Order number	Bestell-Nr. / Order number	Bestell-Nr. / Order number	Bestell-Nr. / Order number
		Torx-Schlüssel/ Torx driver	Torx-Schraube Torx screw	Zwischenlage/ Tip pad	Schraube/ Screw
xxx.KGB.RGR.xxx	G01	WGB.ER1.001.000	WGB.ER2.001.012 (2.0 Nm)	WGB.ER2.102.003	WGB.ER3.001.007 (2.0 Nm)
xxx.KGB.LGR.xxx	G02	WGB.ER1.001.000	WGB.ER2.001.012 (2.0 Nm)	WGB.ER2.101.003	WGB.ER3.001.007 (2.0 Nm)
xxx.xGB.RGA.xxx	G03	WGB.ER1.001.000	WGB.ER2.001.012 (2.0 Nm)	WGB.ER2.101.003	WGB.ER3.001.007 (2.0 Nm)
xxx.xGB.LGA.xxx	G04	WGB.ER1.001.000	WGB.ER2.001.012 (2.0 Nm)	WGB.ER2.102.003	WGB.ER3.001.007 (2.0 Nm)

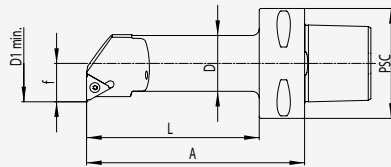

Bestell-Nr. / Order number / Code	PSC	f	D	D1 min.	A	L	Wendeplatte/ Insert/ Plaquette	kg				
PS6.BGB.RGA.125	63	22	32	40	125	103	16 IL	1.30	WGB.ER1.001.000	WGB.ER2.001.012 (2.0 Nm)	WGB.ER2.102.003	WGB.ER3.001.007 (2.0 Nm)
PS6.BGB.LGA.125	63	22	32	40	125	103	16 IR	1.30	WGB.ER1.001.000	WGB.ER2.001.012 (2.0 Nm)	WGB.ER2.101.003	WGB.ER3.001.007 (2.0 Nm)
PS6.BGB.RGA.140	63	27	40	50	140	138	16 IL	1.75	WGB.ER1.001.000	WGB.ER2.001.012 (2.0 Nm)	WGB.ER2.102.003	WGB.ER3.001.007 (2.0 Nm)
PS6.BGB.LGA.140	63	27	40	50	140	138	16 IR	1.75	WGB.ER1.001.000	WGB.ER2.001.012 (2.0 Nm)	WGB.ER2.101.003	WGB.ER3.001.007 (2.0 Nm)

Wechselschneidköpfe für  
Innengewinde

Exchangeable cutting heads for  
Internal thread

Têtes de coupe interchangeables  
pour le filetage interne

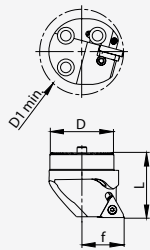

Bestell-Nr. / Order number / Code	D	D1 min.	f	L	Wendeplatte/ Insert/ Plaquette	kg				
WK4.BGB.RGZ.025	20	25	14	25	16 IL	0.08	WGB.ER1.001.000	WGB.ER2.001.012 (2.0 Nm)	WGB.ER2.102.003	WGB.ER3.001.007 (2.0 Nm)
WK4.BGB.LGZ.025	20	25	14	25	16 IR	0.08	WGB.ER1.001.000	WGB.ER2.001.012 (2.0 Nm)	WGB.ER2.101.003	WGB.ER3.001.007 (2.0 Nm)
WK3.BGB.RGA.035	25	32	17	35	16 IL	0.10	WGB.ER1.001.000	WGB.ER2.001.012 (2.0 Nm)	WGB.ER2.102.003	WGB.ER3.001.007 (2.0 Nm)
WK3.BGB.LGA.035	25	32	17	35	16 IR	0.10	WGB.ER1.001.000	WGB.ER2.001.012 (2.0 Nm)	WGB.ER2.101.003	WGB.ER3.001.007 (2.0 Nm)
WK2.BGB.RGB.040	32	40	22	40	16 IL	0.18	WGB.ER1.001.000	WGB.ER2.001.012 (2.0 Nm)	WGB.ER2.102.003	WGB.ER3.001.007 (2.0 Nm)
WK2.BGB.LGB.040	32	40	22	40	16 IR	0.18	WGB.ER1.001.000	WGB.ER2.001.012 (2.0 Nm)	WGB.ER2.101.003	WGB.ER3.001.007 (2.0 Nm)
WK1.BGB.RGC.040	40	50	27	40	16 IL	0.30	WGB.ER1.001.000	WGB.ER2.001.012 (2.0 Nm)	WGB.ER2.102.003	WGB.ER3.001.007 (2.0 Nm)
WK1.BGB.LGC.040	40	50	27	40	16 IR	0.30	WGB.ER1.001.000	WGB.ER2.001.012 (2.0 Nm)	WGB.ER2.101.003	WGB.ER3.001.007 (2.0 Nm)

## Bohrstangen mit Wechselschneidköpfen

- für effiziente Drehbearbeitung
- optimale Kühlung durch ausgerichtete Kühldüse und Hochdruckkühldüse



HP  
inside

## Boring bars with exchangeable cutting heads

- to turn efficiently
- optimal cooling by adjusted cooling nozzle and high pressure cooling nozzle

## Barres d'alésage avec têtes de coupe interchangeables

- pour des opérations de tournage efficaces
- arrosage optimal par des buses d'arrosage fixes High Pressure

## Bohrstangenschäfte

## Boring bar shanks

## Barres d'alésage

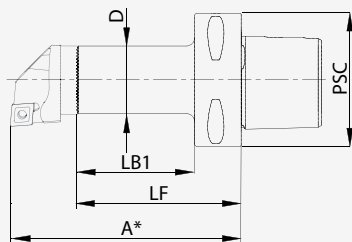

HP  
inside

Bestell-Nr. / Order number/ Code	PSC	D	A*	LF	LB1	kg	
PS4.WK5.016.062	40	16	62	42	22	0.30	NH.762.003.010
PS4.WK4.020.072	40	20	72	52	32	0.43	NH.762.035.012
PS4.WK3.025.090	40	25	90	55	35	0.82	NH.762.004.012
PS4.WK2.032.065	40	32	65	30	15	0.90	NH.762.005.014
PS4.WK2.032.110	40	32	110	75	55	0.58	NH.762.005.014
PS4.WK1.040.120	40	40	120	80	-	0.82	NH.762.006.016
PS5.WK5.016.062	50	16	62	42	22	0.40	NH.762.003.010
PS5.WK4.020.072	50	20	72	52	32	0.52	NH.762.035.012
PS5.WK3.025.090	50	25	90	55	35	0.54	NH.762.004.012
PS5.WK2.032.110	50	32	110	90	55	0.75	NH.762.005.014
PS5.WK1.040.140	50	40	140	100	80	1.18	NH.762.006.016
PS6.WK5.016.062	63	16	62	42	20	0.45	NH.762.003.010
PS6.WK4.020.072	63	20	72	52	32	0.60	NH.762.035.012
PS6.WK3.025.100	63	25	100	65	43	0.90	NH.762.004.012
PS6.WK2.032.125	63	32	125	90	68	1.15	NH.762.005.014
PS6.WK2.032.160	63	32	160	125	103	1.36	NH.762.005.014
PS6.WK1.040.140	63	40	140	100	78	1.48	NH.762.006.016
PS6.WK1.040.180	63	40	180	140	118	1.87	NH.762.006.016

## Bohrstangenschäfte mit Zylinderschaft

- Anschlussgewinde für Innenkühlung
- 3 Spannflächen

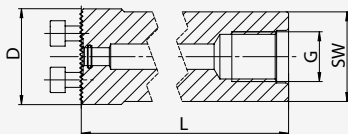

## Boring bar shanks with cylindrical shank

- with thread for inner coolant supply
- 3 clamping flats

## Barres d'alésage avec tige cylindrique

- Filet pour l'arrosage interne
- 3 surfaces de serrage

HP  
inside

Bestell-Nr. / Order number/ Code	D	L	SW	G	kg	
U25.WK3.025.200	25	200	23	G1/4	0.65	NH.762.004.012
U32.WK2.032.218	32	218	30	G3/8	1.22	NH.762.005.014
U40.WK1.040.283	40	283	37	G1/2	2.46	NH.762.006.016

**Schwingungsgedämpfte  
Bohrstangenschäfte (HM-Kern)**

**Damped  
boring bar shanks (carbide core)**

**Tiges de barres  
d'alésage anti-vibrations**

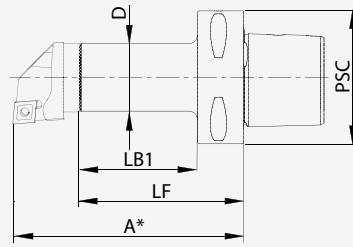



Bestell-Nr. / Order number/ Code	PSC	D	A*	LF	LB1	kg	
PS6.WK3.025.150	63	25	150	115	93	0.98	Ni4.762.004.012
PS6.WK2.032.185	63	32	185	150	128	1.76	Ni4.762.005.014
PS6.WK1.040.225	63	40	225	185	163	2.20	Ni4.762.006.016

**Schwingungsgedämpfte  
Bohrstangenschäfte  
Tilgersystem / Massendämpfer**

**Damped  
boring bar shanks  
Tilger system / Mass damper**

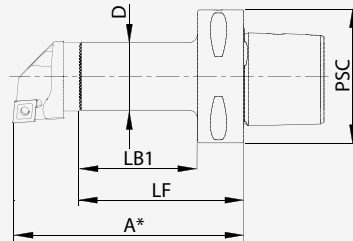
**Tiges de barres  
d'alésage anti-vibrations  
Système Tilger / Amortisseur masse**



Bestell-Nr. / Order number/ Code	PSC	D	A*	LF	LB1	kg	
PS4.WK5.WD0.108	40	16	108	88	63	0.40	Ni4.762.003.010
PS4.WK4.WD1.127	40	20	127	107	83	0.54	Ni4.762.035.012
PS4.WK3.WD2.167	40	25	167	132	108	0.80	Ni4.762.004.012
PS4.WK2.WD3.189	40	32	189	154	131	1.22	Ni4.762.005.014
PS4.WK1.WD4.213	40	40	213	173	-	1.74	Ni4.762.006.016
PS5.WK5.WD0.105	50	16	105	85	58	0.57	Ni4.762.003.010
PS5.WK4.WD1.129	50	20	129	109	83	0.75	Ni4.762.035.012
PS5.WK3.WD2.168	50	25	168	133	107	1.00	Ni4.762.004.012
PS5.WK3.WD2.215	50	25	215	180	154	1.23	Ni4.762.004.012
PS5.WK2.WD3.189	50	32	189	154	129	1.40	Ni4.762.005.014
PS5.WK2.WD3.259	50	32	259	224	199	1.88	Ni4.762.005.014
PS5.WK1.WD4.234	50	40	234	194	170	2.24	Ni4.762.006.016
PS5.WK1.WD4.328	50	40	328	288	263	3.62	Ni4.762.006.016
PS6.WK5.WD0.110	63	16	110	88	58	1.01	Ni4.762.003.010
PS6.WK4.WD1.130	63	20	130	108	78	1.00	Ni4.762.035.012
PS6.WK3.WD2.167	63	25	167	132	103	1.50	Ni4.762.004.012
PS6.WK3.WD2.215	63	25	215	180	146	1.60	Ni4.762.004.012
PS6.WK3.WD2.265	63	25	265	230	197	1.70	Ni4.762.004.012
PS6.WK2.WD3.194	63	32	194	159	130	1.80	Ni4.762.005.014
PS6.WK2.WD3.259	63	32	259	224	191	2.22	Ni4.762.005.014
PS6.WK2.WD3.323	63	32	323	288	258	2.70	Ni4.762.005.014
PS6.WK1.WD4.238	63	40	238	198	169	2.60	Ni4.762.006.016
PS6.WK1.WD4.328	63	40	328	288	257	3.95	Ni4.762.006.016
PS6.WK1.WD4.408	63	40	408	368	339	4.20	Ni4.762.006.016

**SCLC R/L**

K<sub>r</sub> 95° (-5°)

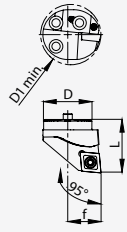

**PCLN R/L**

K<sub>r</sub> 95° (-5°)

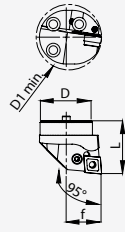
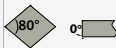

Typ/ Type/ Type	Bestell-Nr./ Order number/ Code	D	D1 min.	f	L	Wendeplatte/ Insert/ Plaquette	kg						
SCLCR/L	WK5.BCA.(R/L)LY.020	16	20	11	20	CC..06 02..	0.05	WCA.ER1.001.000	WCA.ER2.001.006 (0.9 Nm)				
SCLCR/L	WK4.BCB.(R/L)LZ.020	20	25	13	20	CC..09 T3..	0.08	WCB.ER1.001.000	WCB.ER2.001.009 (3.0 Nm)				
SCLCR/L	WK3.BCB.(R/L)LA.035	25	32	17	35	CC..09 T3..	0.10	WCB.ER1.001.000	WCB.ER2.001.009 (3.0 Nm)				
SCLCR/L	WK3.BCC.(R/L)LA.035	25	32	17	35	CC..12 04..	0.10	WCC.ER1.001.000	WCC.ER2.001.010 (5.0 Nm)				
SCLCR/L	WK2.BCC.(R/L)LB.035	32	40	22	35	CC..12 04..	0.20	WCC.ER1.001.000	WCC.ER2.001.010 (5.0 Nm)				
SCLCR/L	WK1.BCC.(R/L)LC.040	40	50	27	40	CC..12 04..	0.30	WCC.ER1.001.000	WCC.ER2.001.010 (5.0 Nm)				
PCLN R/L	WK3.PCD.(R/L)LA.035	25	32	17	35	CN..12 04..	0.10	WCD.ER2.101.003	WCD.ER4.101.017 (5.0 Nm)	WCD.ER3.101.000	WCD.ER1.101.000		
PCLN R/L	WK2.PCD.(R/L)LB.035	32	40	22	35	CN..12 04..	0.20	WCD.ER2.101.003	WCD.ER4.101.017 (5.0 Nm)	WCD.ER3.101.000	WCD.ER1.101.000		
PCLN R/L	WK1.PCD.(R/L)LC.040	40	50	27	40	CN..12 04..	0.30	WCD.ER2.101.003	WCD.ER4.101.017 (5.0 Nm)	WCD.ER3.101.000	WCD.ER1.101.000		

**SVPB R/L**

K<sub>r</sub> 117.5° (-27.5°)

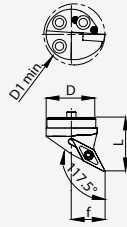
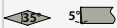

**SVUB R/L**

K<sub>r</sub> 93° (-3°)

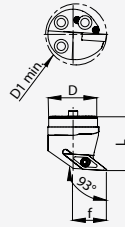
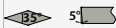

**SVQB R/L**

K<sub>r</sub> 107.5° (-17.5°)

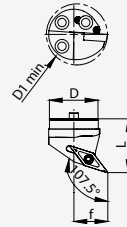

Typ/ Type/ Type	Bestell-Nr./ Order number/ Code	D	D1 min.	f	L	Wendeplatte/ Insert/ Plaquette	kg						
SVPB R/L	WK3.BVE.(R/L)PA.035	25	32	17	35	VB..11 03..	0.10	WCB.ER1.001.000	WCB.ER2.001.009 (3.0 Nm)				
SVPB R/L	WK2.BVF.(R/L)PB.035	32	40	22	35	VB..16 04..	0.20	WCB.ER1.001.000	WCB.ER2.001.009 (3.0 Nm)				
SVPB R/L	WK1.BVF.(R/L)PC.040	40	50	27	40	VB..16 04..	0.30	WCB.ER1.001.000	WCB.ER2.001.009 (3.0 Nm)				
SVUB R/L	WK4.BVE.(R/L)UZ.020	20	27	16	20	VB..11 03..	0.08	WCB.ER1.001.000	WCB.ER2.001.009 (3.0 Nm)				
SVUB R/L	WK3.BVE.(R/L)UA.035	25	32	17	35	VB..11 03..	0.10	WCB.ER1.001.000	WCB.ER2.001.009 (3.0 Nm)				
SVUB R/L	WK2.BVF.(R/L)UB.035	32	40	22	35	VB..16 04..	0.20	WCB.ER1.001.000	WCB.ER2.001.009 (3.0 Nm)				
SVUB R/L	WK1.BVF.(R/L)UC.040	40	50	27	40	VB..16 04..	0.30	WCB.ER1.001.000	WCB.ER2.001.009 (3.0 Nm)				
SVQB R/L	WK4.BVE.(R/L)QZ.020	20	27	15	20	VB..11 03..	0.08	WCB.ER1.001.000	WCB.ER2.001.009 (3.0 Nm)				
SVQB R/L	WK3.BVE.(R/L)QA.035	25	32	17	35	VB..11 03..	0.10	WCB.ER1.001.000	WCB.ER2.001.009 (3.0 Nm)				
SVQB R/L	WK2.BVF.(R/L)QB.035	32	40	22	35	VB..16 04..	0.20	WCB.ER1.001.000	WCB.ER2.001.009 (3.0 Nm)				
SVQB R/L	WK1.BVF.(R/L)QC.040	40	50	27	40	VB..16 04..	0.30	WCB.ER1.001.000	WCB.ER2.001.009 (3.0 Nm)				



**SDUC R/L**

$K_r 93^\circ (-3^\circ)$

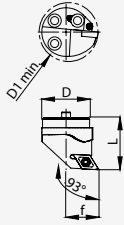
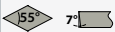

**SDQC R/L**

$K_r 107.5^\circ (-17.5^\circ)$

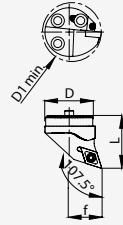
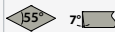

**PDUN R/L**

$K_r 93^\circ (-3^\circ)$

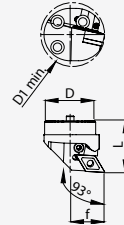

**PDQN R/L**

$K_r 107.5^\circ (-17.5^\circ)$

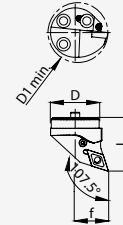

Typ/ Type/ Type	Bestell-Nr. / Order number/ Code	D	D1 min.	f	L	Wendeplatte/ Insert/ Plaquette	kg					
SDUC R/L	WK5.BDA.(R/L)UY.020	16	20	11	20	DC..07 02..	0.05	WCA.ER1.001.000	WCA.ER2.001.006 (0.9 Nm)			
SDUC R/L	WK4.BDB.(R/L)UZ.020	20	25	13	20	DC..11 T3..	0.08	WCB.ER1.001.000	WCB.ER2.001.009 (3.0 Nm)			
SDUC R/L	WK3.BDB.(R/L)UA.035	25	32	17	35	DC..11 T3..	0.10	WCB.ER1.001.000	WCB.ER2.001.009 (3.0 Nm)			
SDUC R/L	WK2.BDB.(R/L)UB.035	32	40	22	35	DC..11 T3..	0.20	WCB.ER1.001.000	WCB.ER2.001.009 (3.0 Nm)			
SDUC R/L	WK1.BDB.(R/L)UC.040	40	50	27	40	DC..11 T3..	0.30	WCB.ER1.001.000	WCB.ER2.001.009 (3.0 Nm)			
SDQC R/L	WK4.BDB.(R/L)QZ.020	20	25	13	20	DC..11 T3..	0.08	WCB.ER1.001.000	WCB.ER2.001.009 (3.0 Nm)			
SDQC R/L	WK3.BDB.(R/L)QA.035	25	32	17	35	DC..11 T3..	0.10	WCB.ER1.001.000	WCB.ER2.001.009 (3.0 Nm)			
SDQC R/L	WK2.BDB.(R/L)QB.035	32	40	22	35	DC..11 T3..	0.20	WCB.ER1.001.000	WCB.ER2.001.009 (3.0 Nm)			
SDQC R/L	WK1.BDB.(R/L)QC.040	40	50	27	40	DC..11 T3..	0.30	WCB.ER1.001.000	WCB.ER2.001.009 (3.0 Nm)			
PDUN R/L	WK3.PDE.(R/L)UA.035	25	32	17	35	DN..11 04..	0.10	WDE.ER2.101.003	WDE.ER4.101.017 (5.0 Nm)	WDE.ER3.101.000	WDE.ER1.101.000	
PDUN R/L	WK2.PDE.(R/L)UB.035	32	40	22	35	DN..11 04..	0.20	WDE.ER2.101.003	WDE.ER4.101.017 (5.0 Nm)	WDE.ER3.101.000	WDE.ER1.101.000	
PDUN R/L	WK1.PDE.(R/L)UC.040	40	50	27	40	DN..11 04..	0.30	WDE.ER2.101.003	WDE.ER4.101.017 (5.0 Nm)	WDE.ER3.101.000	WDE.ER1.101.000	
PDUN R/L	WK2.PDF.(R/L)UB.035	32	40	22	35	DN..15 06..	0.20	WDF.ER2.101.003	WCD.ER4.101.017 (5.0 Nm)	WDF.ER3.101.000	WCD.ER1.101.000	
PDUN R/L	WK1.PDF.(R/L)UC.040	40	50	27	40	DN..15 06..	0.30	WDF.ER2.101.003	WCD.ER4.101.017 (5.0 Nm)	WDF.ER3.101.000	WCD.ER1.101.000	
PDQN R/L	WK3.PDE.(R/L)QA.035	25	32	17	35	DN..11 04..	0.10	WDE.ER2.101.003	WDE.ER4.101.017 (5.0 Nm)	WDE.ER3.101.000	WDE.ER1.101.000	
PDQN R/L	WK2.PDE.(R/L)QB.035	32	40	22	35	DN..11 04..	0.20	WDE.ER2.101.003	WDE.ER4.101.017 (5.0 Nm)	WDE.ER3.101.000	WDE.ER1.101.000	
PDQN R/L	WK1.PDE.(R/L)QC.040	40	50	27	40	DN..11 04..	0.30	WDE.ER2.101.003	WDE.ER4.101.017 (5.0 Nm)	WDE.ER3.101.000	WDE.ER1.101.000	

**PWLN R/L**

$K_r 95^\circ (-5^\circ)$

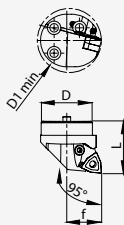



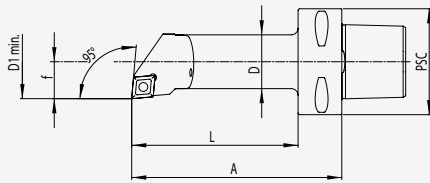
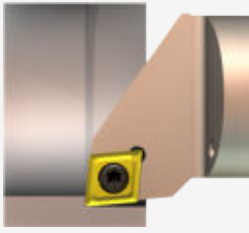

Typ/ Type/ Type	Bestell-Nr. / Order number/ Code	D	D1 min.	f	L	Wendeplatte/ Insert/ Plaquette	kg					
PWLN R/L	WK2.PWE.(R/L)LB.035	32	40	22	35	WN..08 04..	0.20	WWE.ER2.101.004	WCD.ER4.101.017 (5.0 Nm)	WDF.ER3.101.000	WCD.ER1.101.000	
PWLN R/L	WK1.PWE.(R/L)LC.040	40	50	27	40	WN..08 04..	0.30	WWE.ER2.101.004	WCD.ER4.101.017 (5.0 Nm)	WDF.ER3.101.000	WCD.ER1.101.000	

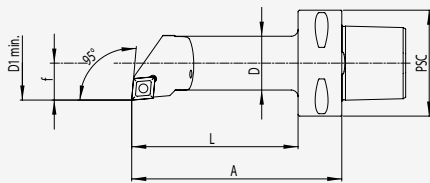
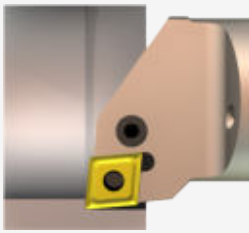



Bestell-Nr. / Order number/ Code	PSC	f	D	D1 min.	A	L	Wendeplatte/ Insert/ Plaquette	kg		
PS4.BCC.(R/L)LA.090	40	17	25	32	90	69	CC..12.04..	0.45	WCC.ER1.001.000	WCC.ER2.001.010 (5.0 Nm)
PS4.BCC.(R/L)LB.110	40	22	32	40	110	89	CC..12.04..	0.68	WCC.ER1.001.000	WCC.ER2.001.010 (5.0 Nm)
PS5.BCC.(R/L)LA.090	50	17	25	32	90	67	CC..12.04..	0.62	WCC.ER1.001.000	WCC.ER2.001.010 (5.0 Nm)
PS5.BCC.(R/L)LB.110	50	22	32	40	110	88	CC..12.04..	0.85	WCC.ER1.001.000	WCC.ER2.001.010 (5.0 Nm)
PS6.BCC.(R/L)LB.125	63	22	32	40	125	103	CC..12.04..	1.26	WCC.ER1.001.000	WCC.ER2.001.010 (5.0 Nm)
PS6.BCC.(R/L)LB.160	63	22	32	40	160	138	CC..12.04..	1.47	WCC.ER1.001.000	WCC.ER2.001.010 (5.0 Nm)
PS6.BCC.(R/L)LC.140	63	27	40	50	140	118	CC..12.04..	1.70	WCC.ER1.001.000	WCC.ER2.001.010 (5.0 Nm)
PS6.BCC.(R/L)LC.180	63	27	40	50	180	158	CC..12.04..	2.07	WCC.ER1.001.000	WCC.ER2.001.010 (5.0 Nm)



Bestell-Nr. / Order number/ Code	PSC	f	D	D1 min.	A	L	Wendeplatte/ Insert/ Plaquette	kg				
PS4.PCD.(R/L)LB.110	40	22	32	40	110	89	CN..12.04..	0.70	WCD.ER2.101.003	WCD.ER4.101.017 (5.0 Nm)	WCD.ER3.101.000	WCD.ER1.101.000
PS5.PCD.(R/L)LB.110	50	22	32	40	110	88	CN..12.04..	0.87	WCD.ER2.101.003	WCD.ER4.101.017 (5.0 Nm)	WCD.ER3.101.000	WCD.ER1.101.000
PS6.PCD.(R/L)LC.140	63	27	40	50	140	118	CN..12.04..	1.71	WCD.ER2.101.003	WCD.ER4.101.017 (5.0 Nm)	WCD.ER3.101.000	WCD.ER1.101.000
PS6.PCD.(R/L)LC.180	63	27	40	50	180	158	CN..12.04..	2.08	WCD.ER2.101.003	WCD.ER4.101.017 (5.0 Nm)	WCD.ER3.101.000	WCD.ER1.101.000

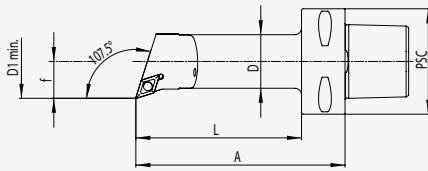
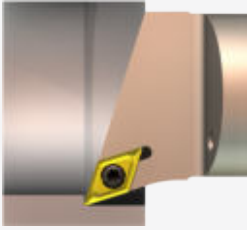



## SDQC R/L 107.5°/55°

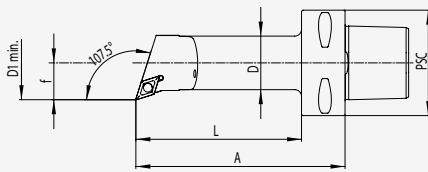
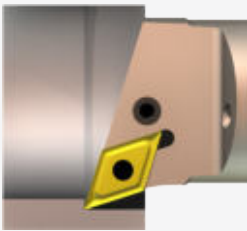

Bestell-Nr. / Order number/ Code	PSC	f	D	D1 min.	A	L	Wendeplatte/ Insert/ Plaquette	kg		
PS4.BDB.(R/L)QA.090	40	17	25	32	90	69	DC..11T3..	0.45	WCB.ER1.001.000	WCB.ER2.001.009 (3.0 Nm)
PS4.BDB.(R/L)QB.110	40	22	32	40	110	89	DC..11T3..	0.68	WCB.ER1.001.000	WCB.ER2.001.009 (3.0 Nm)
PS5.BDB.(R/L)QA.090	50	17	25	32	90	67	DC..11T3..	0.62	WCB.ER1.001.000	WCB.ER2.001.009 (3.0 Nm)
PS5.BDB.(R/L)QB.110	50	22	32	40	110	88	DC..11T3..	0.85	WCB.ER1.001.000	WCB.ER2.001.009 (3.0 Nm)
PS6.BDB.(R/L)QB.125	63	22	32	40	125	103	DC..11T3..	1.26	WCB.ER1.001.000	WCB.ER2.001.009 (3.0 Nm)
PS6.BDB.(R/L)QB.160	63	22	32	40	160	138	DC..11T3..	1.47	WCB.ER1.001.000	WCB.ER2.001.009 (3.0 Nm)
PS6.BDB.(R/L)QC.140	63	27	40	50	140	118	DC..11T3..	1.70	WCB.ER1.001.000	WCB.ER2.001.009 (3.0 Nm)
PS6.BDB.(R/L)QC.180	63	27	40	50	180	158	DC..11T3..	2.07	WCB.ER1.001.000	WCB.ER2.001.009 (3.0 Nm)

## PDQN R/L 107.5°/55°





Bestell-Nr. / Order number/ Code	PSC	f	D	D1 min.	A	L	Wendeplatte/ Insert/ Plaquette	kg				
PS4.PDF.(R/L)QB.110	40	22	32	40	110	89	DN..15 06..*	0.68	WDF.ER2.101.003	WCD.ER4.101.017 (5.0 Nm)	WDF.ER3.101.000	WCD.ER1.101.000
PS5.PDF.(R/L)QB.110	50	22	32	40	110	88	DN..15 06..*	0.86	WDF.ER2.101.003	WCD.ER4.101.017 (5.0 Nm)	WDF.ER3.101.000	WCD.ER1.101.000
PS6.PDF.(R/L)QC.140	63	27	40	50	140	118	DN..15 06..*	1.70	WDF.ER2.101.003	WCD.ER4.101.017 (5.0 Nm)	WDF.ER3.101.000	WCD.ER1.101.000
PS6.PDF.(R/L)QC.180	63	27	40	50	180	158	DN..15 06..*	2.08	WDF.ER2.101.003	WCD.ER4.101.017 (5.0 Nm)	WDF.ER3.101.000	WCD.ER1.101.000

\* DN .. 15 04 .. möglich mit Unterlegplatte  
WDF.ER2.101.004

\* DN .. 15 04 .. possible with tip pad  
WDF.ER2.101.004

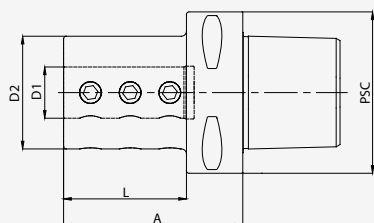
\* DN .. 15 04 .. possible avec plateau de  
support WDF.ER2.101.004



Bestell-Nr. / Order number/ Code	PSC	D1	D2	A	L	kg	
PS4.B06.K01.065	40	6	34	65	43	0.54	ERU.GS4.001.010 (5.0 Nm) M 6 x 10
PS4.B08.K01.065	40	8	34	65	43	0.51	ERU.GS5.001.010 (10.0 Nm) M 8 x 10
PS4.B10.K01.065	40	10	34	65	43	0.50	ERU.GS5.001.010 (10.0 Nm) M 8 x 10
PS4.B12.K01.065	40	12	36	65	43	0.00	ERU.GS5.001.010 (10.0 Nm) M 8 x 10
PS4.B16.K01.065	40	16	40	65	43	0.56	ERU.GS6.001.012 (15.0 Nm) M10 x 12
PS4.B20.K01.065	40	20	44	65	-	0.59	ERU.GS6.001.012 (15.0 Nm) M10 x 12
PS4.B25.K01.065	40	25	44	65	-	0.52	ERU.GS6.001.012 (15.0 Nm) M10 x 12
PS5.B06.K01.035*	50	6	34	35	15	0.52	ERU.GS4.001.010 (5.0 Nm) M 6 x 10
PS5.B06.K01.070	50	6	34	70	48	0.74	ERU.GS4.001.010 (5.0 Nm) M 6 x 10
PS5.B08.K01.035*	50	8	34	35	15	0.49	ERU.GS5.001.010 (10.0 Nm) M 8 x 10
PS5.B08.K01.070	50	8	34	70	48	0.72	ERU.GS5.001.010 (10.0 Nm) M 8 x 10
PS5.B10.K01.035*	50	10	34	35	15	0.49	ERU.GS5.001.010 (10.0 Nm) M 8 x 10
PS5.B10.K01.070	50	10	34	70	48	0.71	ERU.GS5.001.010 (10.0 Nm) M 8 x 10
PS5.B12.K01.035*	50	12	36	35	15	0.50	ERU.GS5.001.010 (10.0 Nm) M 8 x 10
PS5.B12.K01.070	50	12	36	70	48	0.73	ERU.GS5.001.010 (10.0 Nm) M 8 x 10
PS5.B16.K01.035*	50	16	40	35	15	0.50	ERU.GS6.001.012 (15.0 Nm) M10 x 12
PS5.B16.K01.070	50	16	40	70	48	0.77	ERU.GS6.001.012 (15.0 Nm) M10 x 12
PS5.B20.K01.035*	50	20	44	35	15	0.50	ERU.GS6.001.012 (15.0 Nm) M10 x 12
PS5.B20.K01.070	50	20	44	70	48	0.82	ERU.GS6.001.012 (15.0 Nm) M10 x 12
PS5.B25.K01.035*	50	25	50	35	-	0.48	ERU.GS6.001.012 (15.0 Nm) M10 x 12
PS5.B25.K01.070	50	25	50	70	-	0.91	ERU.GS6.001.012 (15.0 Nm) M10 x 12
PS5.B32.K01.070	50	32	56	70	-	0.94	ERU.GS6.001.012 (15.0 Nm) M10 x 12
PS6.B06.K01.080	63	6	34	80	58	1.13	ERU.GS4.001.010 (5.0 Nm) M 6 x 10
PS6.B08.K01.080	63	8	34	80	58	1.10	ERU.GS5.001.010 (10.0 Nm) M 8 x 10
PS6.B10.K01.080	63	10	34	80	58	1.09	ERU.GS5.001.010 (10.0 Nm) M 8 x 10
PS6.B12.K01.080	63	12	36	80	58	1.12	ERU.GS5.001.010 (10.0 Nm) M 8 x 10
PS6.B14.K01.080	63	14	38	80	58	0.00	ERU.GS5.001.010 (10.0 Nm) M 8 x 10
PS6.B16.K01.080	63	16	40	80	58	1.17	ERU.GS6.001.012 (15.0 Nm) M10 x 12
PS6.B18.K01.080	63	18	42	80	58	0.00	ERU.GS6.001.012 (15.0 Nm) M10 x 12
PS6.B20.K01.080	63	20	44	80	58	1.26	ERU.GS6.001.012 (15.0 Nm) M10 x 12
PS6.B25.K01.100	63	25	50	100	78	1.62	ERU.GS6.001.012 (15.0 Nm) M10 x 12
PS6.B32.K01.100	63	32	56	100	78	1.75	ERU.GS6.001.012 (15.0 Nm) M10 x 12
PS6.B40.K01.105	63	40	63	105	83	1.98	ERU.GS6.001.012 (15.0 Nm) M10 x 12
PS8.B10.K01.098	80	10	34	98	68	2.08	ERU.GS5.001.010 (10.0 Nm) M 8 x 10
PS8.B12.K01.098	80	12	36	98	68	2.12	ERU.GS5.001.010 (10.0 Nm) M 8 x 10
PS8.B16.K01.098	80	16	40	98	68	2.20	ERU.GS6.001.012 (15.0 Nm) M10 x 12
PS8.B20.K01.098	80	20	44	98	68	2.30	ERU.GS6.001.012 (15.0 Nm) M10 x 12
PS8.B25.K01.098	80	25	50	98	68	2.46	ERU.GS6.001.012 (15.0 Nm) M10 x 12
PS8.B32.K01.112	80	32	56	112	82	2.78	ERU.GS6.001.012 (15.0 Nm) M10 x 12
PS8.B40.K01.112	80	40	63	112	82	2.97	ERU.GS6.001.012 (15.0 Nm) M10 x 12
PS8.B50.K01.112	80	50	82	112	-	3.65	ERU.GS6.001.012 (15.0 Nm) M10 x 12

\* ohne Gewinde für Kühlmittelrohr

\* without thread for coolant pipe

\* sans filetage pour tuyau de liquide de refroidissement

## Schwingungsgedämpfte Bohrstangenhalter

## Damped Boring bar holder

## Tiges de porte-outils d'alésage anti-vibrations

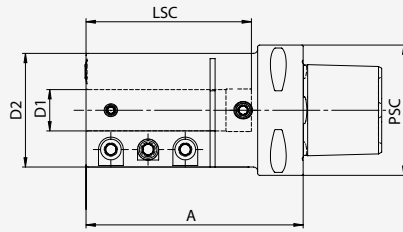

Bestell-Nr. / Order number/ Code	PSC	D1	D2	A	LSC	kg					
PS6.B10.K21.105	63	10	45	105	-	1.53	Ni4.027.006.016	Ni4.028.008.016	Ni4.028.010.016	Ni4.762.006.016	KU1.U12.002.010
PS6.B12.K21.105	63	12	45	105	-	1.61	Ni4.027.006.016	Ni4.028.008.016	Ni4.028.010.016	Ni4.762.006.016	KU1.U12.002.010
PS6.B16.K21.105	63	16	45	105	-	1.54	Ni4.027.006.016	Ni4.028.008.016	Ni4.028.010.016	Ni4.762.006.016	KU1.U12.002.010
PS6.B20.K21.105	63	20	55	105	80	1.97	Ni4.027.006.016	Ni4.028.008.016	Ni4.028.010.016	Ni4.762.006.016	KU1.U12.002.010
PS6.B25.K21.105	63	25	55	105	80	1.86	Ni4.027.006.016	Ni4.028.008.016	Ni4.028.010.016	Ni4.762.006.016	KU1.U12.002.010
PS6.B32.K21.105	63	32	65	105	85	2.19	Ni4.027.006.016	Ni4.028.008.016	Ni4.028.010.016	Ni4.762.006.016	KU1.U12.002.010
PS6.B40.K21.105	63	40	75	105	85	2.44	Ni4.027.006.016	Ni4.028.008.012	Ni4.028.010.016	Ni4.762.006.016	KU1.U12.002.010

• mehr Stabilität und schwingungsdämpfende Wirkung durch Umschlingung der Bohrstan-ge

• more stability and vibration dampening effect by wrapping around the boring bar

\* plus de stabilité et un effet d'amortissement des vibrations en s'enroulant autour de la barre d'alésage

## Werkzeughalter für Wendepplattenbohrer

## Toolholder for indexable insert drills

## Porte-outils pour fraises à plaquettes indexables

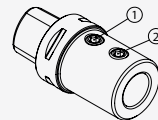
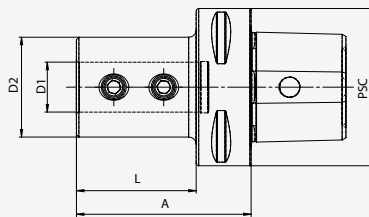

Bestell-Nr. / Order number/ Code	PSC	D1	D2	A	L	kg		
PS4.K16.K01.056	40	16	36	56	36	1.22	K16.ER1.010.010	
PS4.K20.K01.060	40	20	40	60	-	1.22	K20.ER1.010.012	K20.ER2.010.014
PS4.K25.K01.077	40	25	45	77	-	1.22	K32.ER1.012.012	K32.ER2.012.014
PS5.K16.K01.065	50	16	36	65	45	1.22	K16.ER1.010.010	
PS5.K20.K01.060	50	20	40	60	40	1.22	K20.ER1.010.012	K20.ER2.010.014
PS5.K25.K01.071	50	25	45	71	51	1.22	K20.ER1.010.012	K20.ER2.010.014
PS5.K32.K01.075	50	32	52	75	-	1.22	K32.ER1.012.012	K32.ER2.012.014
PS6.K16.K01.070	63	16	36	70	48	1.22	K16.ER1.010.010	
PS6.K20.K01.070	63	20	40	70	48	1.09	K20.ER1.010.012	K20.ER2.010.014
PS6.K25.K01.072	63	25	45	72	50	1.14	K20.ER1.010.012	K20.ER2.010.014
PS6.K32.K01.075	63	32	52	75	53	1.23	K32.ER1.012.012	K32.ER2.012.014
PS6.K40.K01.085	63	40	63	85	-	1.55	K40.ER1.016.012	K40.ER2.016.014

• zum Spannen von Zylinderschäften nach DIN 6595-1 / ISO 9766

• to clamp cylindrical shanks DIN 6595-1 / ISO 9766

\* pour le serrage de tiges cylindriques selon DIN 6595-1 / ISO 9766

**Abstechhalter radial  
mit ECO / Direct Coolant**

**Cut-off block radial  
with ECO / direct coolant**

**Bloc de tronçonnage radial  
ECO / direct coolant**

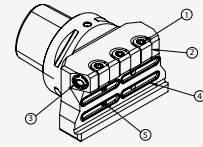
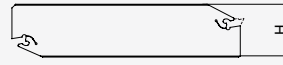
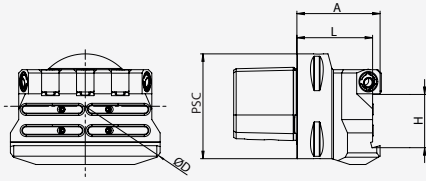

Bestell-Nr. / Order number/ Code	PSC	A	H	L	ØD	rechts/links right/left droite/gauche	kg	1	2	3	4	5
PS4.AE2.N11.045-ECO	40	45	26	40.5	90	R/L	0.77					
PS5.AE2.N11.045-ECO	50	45	26	40.5	90	R/L	0.98					
PS6.AE3.N11.050-ECO	63	50	32	45.5	100	R/L	1.53					

- zur Aufnahme von Stechschwertern
- mit Innenkühlung
- mit ECO / direct coolant

- to hold cut-off blades
- with inner coolant supply
- with ECO / direct coolant

- pour tenir les lames de coupe
- avec arrosage interne
- ECO / direct coolant

**Abstechhalter radial**

**Cut-off block radial**

**Bloc de tronçonnage radial**

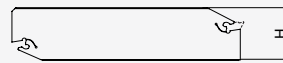
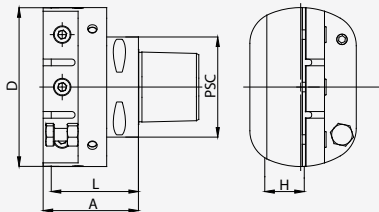

Bestell-Nr. / Order number/ Code	PSC	A	H	L	ØD	rechts/links right/left droite/gauche	kg	
PS4.AM2.K11.055	40	55	26	50.5	80	R/L	1.18	
PS5.AM3.K11.058	50	58	26	53	80	R/L	1.48	
PS6.AM3.K11.060	63	60	32	54.5	100	R/L	2.35	

- zur Aufnahme von Stechschwertern
- mit Innenkühlung

- to hold cut-off blades
- with inner coolant supply t

- pour tenir les lames de coupe
- avec arrosage interne

**Abstechhalter axial  
mit ECO / Direct Coolant**

**Cut-off block axial  
with ECO / direct coolant**

**Bloc de tronçonnage axial  
ECO / direct coolant**

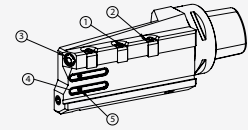
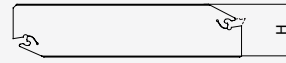
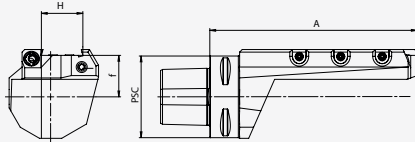

Bestell-Nr. / Order number/ Code	PSC	f	A	H	ØD	rechts/links right/left droite/gauche	kg	1	2	3	4	5
PS4.AE2.R11.122-ECO	40	21	122	26	80	R	1.05	AE3.ER1.006.028	AE3.ER1.011.014	KU1.U12.002.010	ND3.771.023.001	NI4.026.004.004
PS4.AE2.L11.122-ECO	40	21	122	26	80	L	1.05	AE3.ER1.006.028	AE3.ER1.011.014	KU1.U12.002.010	ND3.771.023.001	NI4.026.004.004
PS5.AE2.R11.122-ECO	50	26	122	26	90	R	1.28	AE3.ER1.006.028	AE3.ER1.011.014	KU1.U12.002.010	ND3.771.023.001	NI4.026.004.004
PS5.AE2.L11.122-ECO	50	26	122	26	90	L	1.28	AE3.ER1.006.028	AE3.ER1.011.014	KU1.U12.002.010	ND3.771.023.001	NI4.026.004.004
PS6.AE3.R11.160-ECO	63	22	160	32	105	R	3.33	AE3.ER1.006.028	AE3.ER1.011.014	KU1.U12.002.010	ND3.771.025.001	NI4.026.004.004
PS6.AE3.L11.160-ECO	63	22	160	32	105	L	3.33	AE3.ER1.006.028	AE3.ER1.011.014	KU1.U12.002.010	ND3.771.025.001	NI4.026.004.004

- zur Aufnahme von Stechschwertern
- mit Innenkühlung
- mit ECO / direct coolant

- to hold cut-off blades
- with inner coolant supply
- with ECO / direct coolant

- pour tenir les lames de coupe
- avec arrosage interne
- ECO / direct coolant

**Abstechhalter axial  
mit ECO / Direct Coolant**

**Cut-off block axial  
with ECO / direct coolant**

**Bloc de tronçonnage axial  
ECO / direct coolant**

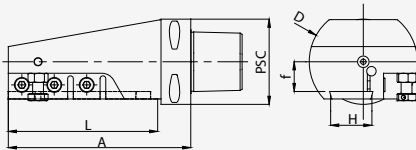

Bestell-Nr. / Order number/ Code	PSC	f	A	H	L	ØD	rechts/links right/left droite/gauche	kg	
PS5.AM3.K11.095	50	22	95	26	75	80	R	2.05	NI4.762.006.016
PS5.AM3.K12.095	50	22	95	26	75	80	L	2.05	NI4.762.006.016
PS6.AM3.K11.145	63	22	145	32	110	80	R	3.73	NI4.762.006.016
PS6.AM3.K12.145	63	22	145	32	110	80	L	3.73	NI4.762.006.016

- zur Aufnahme von Stechschwertern
- mit Innenkühlung
- mit ECO / direct coolant

- to hold cut-off blades
- with inner coolant supply
- with ECO / direct coolant





- pour tenir les lames de coupe
- avec arrosage interne
- ECO / direct coolant

**Werkzeughalter radial  
mit ECO / Direct Coolant**

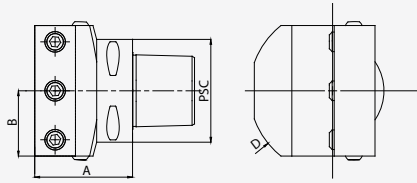
**Tool holder radial  
with ECO / direct coolant**

**Porte-outil radial  
ECO / direct coolant**



Bestell-Nr. / Order number/ Code	PSC	B	Vier- kant Square	A	L	kg					
PS4.V20.N11.055-HP	40	30	20x20	55	80	0.87	NI4.026.010.020	KU1.U12.002.010			
PS6.V2X.N11.071-HP	63	40	25x25 20x20*	71	102	1.94	NI4.026.012.016	KU1.U12.002.010	V2X.ER1.025.055	V2X.ER1.025.080	NI4.762.006.016

- für effiziente Drehbearbeitung
- optimale Kühlung durch einstellbare Hochdruck Kugelspritzdüsen
- mit ECO / direct coolant
- Kühlmittelübergabe zum Werkzeugschaft
- \* Unterlegplatte für Schaft 20x20 nicht im Lieferumfang enthalten

- to turn efficiently
- optimal cooling through adjustable high pressure ball spray nozzles
- with ECO / direct coolant
- coolant transfer into tool shank
- \* shim for shaft 20x20 not included in delivery



- pour un tournage efficace
- refroidissement optimal grâce à des buses de pulvérisation à bille haute pression réglables
- avec ECO / direct coolant
- Transfert de liquide de refroidissement vers la queue de l'outil
- \* Plaque de rondelle pour arbre 20x20 non comprise dans la livraison

**Werkzeughalter radial**

**Tool holder radial**

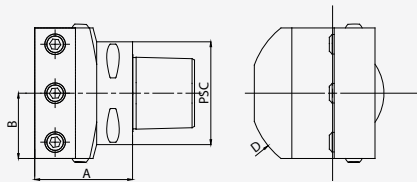
**Porte-outil radial**



Bestell-Nr. / Order number/ Code	PSC	B	Vier- kant Square	A	L	kg		
PS4.V20.N11.055	40	30	20x20	55	80	0.87	NI4.026.010.020	KU1.U12.001.010
PS5.V20.N11.058	50	30	20x20	58	80	1.16	NI4.026.010.020	KU1.U12.001.010
PS5.V25.N11.058	50	30	25x25	58	80	1.16	NI4.026.012.020	KU1.U12.001.010
PS6.V20.N11.060	63	30	20x20	60	80	1.55	NI4.026.010.020	KU1.U12.001.010
PS6.V25.N11.071	63	40	25x25	71	102	2.31	NI4.026.012.020	KU1.U12.001.010
PS8.V32.N11.085	80	55	32x32	85	132	4.75	NI4.026.012.025	KU1.U12.001.010





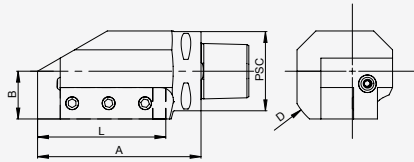

**Werkzeughalter axial  
mit ECO / Direct Coolant**

**Tool holder axial  
with ECO / direct coolant**

**Porte-outil axial  
ECO / direct coolant**



Bestell-Nr. / Order number/ Code	PSC	B	Vier- kant Square	A	L	ØD	kg					
PS6.V2X.(R/L)11.130-HP	63	38	25x25 20x20*	130	102	100	3.34	Ni4.026.012.016	KU1.U12.002.010	V2X.ER1.025.066	V2X.ER2.025.082(R) V2X.ER1.025.082(L)	Ni4.762.006.016
PS8.V25.(R/L)11.130-HP	80	40	25x25	130	102	110	5.43	Ni4.026.012.016	KU1.U12.002.010			

- für effiziente Drehbearbeitung
- optimale Kühlung durch einstellbare Hochdruck Kugelspritzdüsen
- mit ECO / direct coolant
- Kühlmittelübergabe zum Werkzeugschaft
- \* Unterlegplatte für Schaft 20x20 nicht im Lieferumfang enthalten

- to turn efficiently
- optimal cooling through adjustable high pressure ball spray nozzles
- with ECO / direct coolant
- coolant transfer into tool shank
- \* shim for shaft 20x20 not included in delivery



- pour un tournage efficace
- refroidissement optimal grâce à des buses de pulvérisation à bille haute pression réglables
- avec ECO / direct coolant
- Transfert de liquide de refroidissement vers la queue de l'outil
- \* Plaque de rondelle pour arbre 20x20 non comprise dans la livraison

**Werkzeughalter axial**

**Tool holder axial**

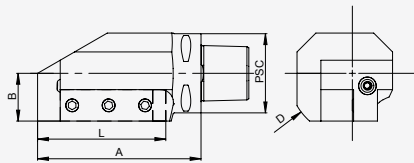
**Porte-outil axial**







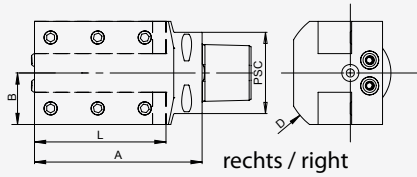

Bestell-Nr. / Order number/ Code	PSC	B	Vier- kant Square	A	L	ØD	kg		
PS4.V20.(R/L)11.080	40	30	20x20	80	60	80	1.04	Ni4.026.010.020	KU1.U12.001.010
PS4.V25.(R/L)11.080	40	31	25x25	80	56	80	1.04	Ni4.026.012.025	KU1.U12.001.010
PS5.V20.(R/L)11.098	50	30	20x20	98	75	80	1.68	Ni4.026.010.020	KU1.U12.001.010
PS5.V25.(R/L)11.098	50	35	25x25	98	75	95	1.68	Ni4.026.010.020	KU1.U12.001.010
PS6.V20.(R/L)11.100	63	30	20x20	100	75	80	2.20	Ni4.026.010.020	KU1.U12.001.010
PS6.V25.(R/L)11.130	63	38	25x25	130	102	102	3.47	Ni4.026.012.020	KU1.U12.001.010
PS8.V32.(R/L)11.140	80	40	32x32	140	98	110	5.43	Ni4.026.012.030	KU1.U12.001.010

**Werkzeughalter axial doppelt  
mit ECO / Direct Coolant**

**Tool holder axial double  
with ECO / direct coolant**

**Porte-outil axial double  
ECO / direct coolant**



Bestell-Nr. / Order number/ Code	PSC	B	Vier- kant Square	A	L	ØD	kg					
PS6.V2X.R21.130-HP	63	40	25x25 20x20*	130	102	100	3.42	KU1.U12.002.010	V2X.ER1.025.066	V2X.ER2.025.082(R) V2X.ER1.025.082(L)	NI4.762.006.016	NI4.762.006.016
PS8.V25.(R/L)11.130-HP	80	40	25x25	130	102	110	6.10	KU1.U12.002.010	V2X.ER1.025.066			

- für effiziente Drehbearbeitung
- optimale Kühlung durch einstellbare Hochdruck Kugelspritzdüsen
- mit ECO / direct coolant
- Kühlmittelübergabe zum Werkzeugschaft
- \* Unterlegplatte für Schaft 20x20 nicht im Lieferumfang enthalten

- to turn efficiently
- optimal cooling through adjustable high pressure ball spray nozzles
- with ECO / direct coolant
- coolant transfer into tool shank
- \* shim for shaft 20x20 not included in delivery



- pour un tournage efficace
- refroidissement optimal grâce à des buses de pulvérisation à bille haute pression réglables
- avec ECO / direct coolant
- Transfert de liquide de refroidissement vers la queue de l'outil
- \* Plaque de rondelle pour arbre 20x20 non comprise dans la livraison

**Werkzeughalter axial doppelt**

**Tool holder axial double**

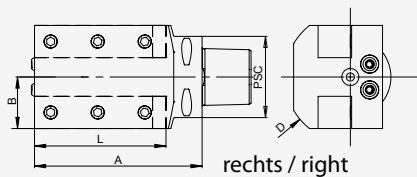
**Porte-outil axial double**



Bestell-Nr. / Order number/ Code	PSC	B	Vier- kant Square	A	L	ØD	kg		
PS4.V20.(R/L)21.080	40	30	20x20	80	60	80	2.10	NI4.026.010.020	KU1.U12.001.010
PS5.V20.(R/L)21.098	50	30	20x20	98	75	80	2.40	NI4.026.010.025	KU1.U12.001.010
PS6.V20.(R/L)21.100	63	30	20x20	100	75	80	2.60	NI4.026.010.025	KU1.U12.001.010
PS6.V25.(R/L)21.130	63	40	25x25	130	102	102	4.20	NI4.026.012.025	KU1.U12.001.010

**Werkzeughalter axial dreifach**

**Tool holder axial triple**

**Porte-outil axial triple**

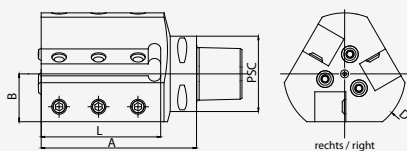





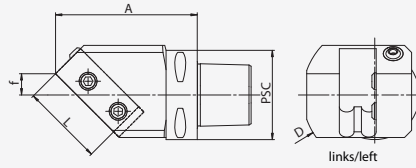

Bestell-Nr. / Order number/ Code	PSC	B	Vier- kant Square	A	L	ØD	kg		
PS5.V16.R31.098	50	30	16x16	98	75	70	1.85	NI4.026.010.020	KU1.U12.001.010
PS5.V20.(R/L)31.123	50	36	20x20	123	97	90	3.47	NI4.026.010.025	KU1.U12.001.010
PS6.V20.(R/L)31.125	63	36	20x20	125	97	90	3.84	NI4.026.010.025	KU1.U12.001.010
PS6.V25.(R/L)31.130	63	40	25x25	130	102	102	4.40	NI4.026.012.020	KU1.U12.001.010

**Werkzeughalter diagonal 45°  
mit ECO / Direct Coolant**

**Tool holder diagonal 45°  
with ECO / direct coolant**

**Porte-outil diagonal 45°  
ECO / direct coolant**



Bestell-Nr. / Order number/ Code	PSC	B	Vier- kant Square	A	ØD	R/L	kg					
PS5.V20.R12.085-HP	50	15	20x20	85	80	R	2.65	Ni4.026.012.016	KU1.U12.002.010			
PS5.V20.L12.085-HP	50	15	20x20	85	80	L	2.65	Ni4.026.012.016	KU1.U12.002.010			
PS6.V2X.R12.110-HP	63	15	25x25 20x20*	110	94	R	2.80	Ni4.026.012.016	KU1.U12.002.010	V2X.ER1.025.061	V2X.ER2.025.079	Ni4.762.006.016
PS6.V2X.L12.110-HP	63	15	25x25 20x20*	110	94	L	2.80	Ni4.026.012.016	KU1.U12.002.010	V2X.ER1.025.061	V2X.ER2.025.079	Ni4.762.006.016

- für effiziente Drehbearbeitung
- optimale Kühlung durch einstellbare Hochdruck Kugelspritzdüsen
- mit ECO / direct coolant
- Kühlmittelübergabe zum Werkzeugschaft
- \* Unterlegplatte für Schaft 20x20 nicht im Lieferumfang enthalten

- to turn efficiently
- optimal cooling through adjustable high pressure ball spray nozzles
- with ECO / direct coolant
- coolant transfer into tool shank
- \* shim for shaft 20x20 not included in delivery



- pour un tournage efficace
- refroidissement optimal grâce à des buses de pulvérisation à bille haute pression réglables
- avec ECO / direct coolant
- Transfert de liquide de refroidissement vers la queue de l'outil
- \* Plaque de rondelle pour arbre 20x20 non comprise dans la livraison

**Werkzeughalter diagonal 45°**

**Tool holder diagonal 45°**

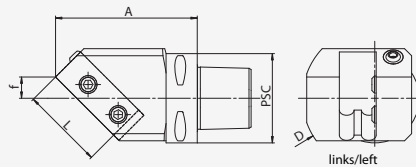
**Porte-outil diagonal 45°**



Bestell-Nr. / Order number/ Code	PSC	B	Vier- kant Square	A	ØD	R/L	kg		
PS5.V20.R12.098	50	15	20x20	98	80	R	2.03	Ni4.026.010.025	KU1.U12.001.010
PS5.V20.L12.098	50	15	20x20	98	80	L	2.03	Ni4.026.010.025	KU1.U12.001.010
PS6.V20.R12.100	63	15	20x20	100	80	R	2.43	Ni4.026.010.025	KU1.U12.001.010
PS6.V20.L12.100	63	15	20x20	100	80	L	2.43	Ni4.026.010.025	KU1.U12.001.010
PS6.V25.R12.110	63	15	25x25	110	102	R	3.37	Ni4.026.012.025	KU1.U12.001.010
PS6.V25.L12.110	63	15	25x25	110	102	L	3.37	Ni4.026.012.025	KU1.U12.001.010

## Verlängerung

## Extension

## Extension

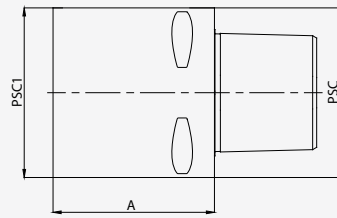

Bestell-Nr. / Order number/ Code	PSC	PSC 1	A	kg
PS4.PS4.K01.060	40	40	60	0.60
PS4.PS4.K01.080	40	40	80	0.70
PS5.PS5.K01.080	50	50	80	1.10
PS5.PS5.K01.100	50	50	100	1.20
PS5.PS5.K01.150	50	50	150	1.60
PS6.PS6.K01.060	63	63	60	1.35
PS6.PS6.K01.100	63	63	100	2.26
PS6.PS6.K01.140	63	63	140	2.65

## Reduktion

## Reduction

## Réduction

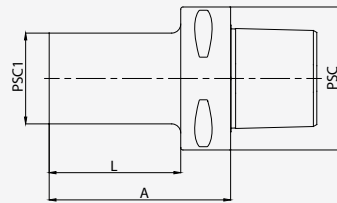

Bestell-Nr. / Order number/ Code	PSC	PSC 1	L	A	kg
PS5.PS4.K01.065	50	40	40	65	0.80
PS6.PS3.K01.070	63	32	48	70	1.15
PS6.PS4.K01.080	63	40	58	80	1.31
PS6.PS5.K01.080	63	50	51	80	1.52
PS8.PS6.K01.080	80	63	50	80	1.35

## Rohling

## Blank

## Ébauche

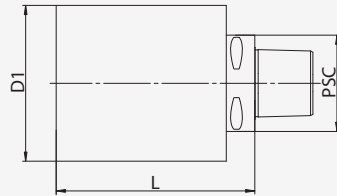

Bestell-Nr. / Order number/ Code	PSC	D1	L	kg
PS4.Ro5.001.050	40	54	50	0.70
PS4.Ro8.001.080	40	80	80	1.10
PS5.Ro7.001.060	50	70	60	1.40
PS5.Ro8.001.098	50	80	98	3.46
PS5.Ro9.001.123	50	90	123	5.47
PS6.Ro6.001.100	63	63	100	2.73
PS6.Ro0.001.130	63	102	130	7.68

## Trennstellenverschluss

## Blanking plug

## Bouchon d'ébauche

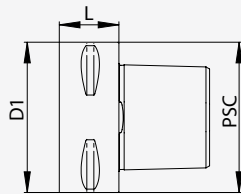

Bestell-Nr. / Order number/ Code	PSC	D1	L	kg
PS4.000.001.020	40	40	20	0.25
PS5.000.001.020	50	50	20	0.42
PS6.000.001.025	63	63	25	0.83

## Kühlmittelrohr Montageschlüssel

## Coolant tube assembling key

## Clé de montage du tube d'arrosage

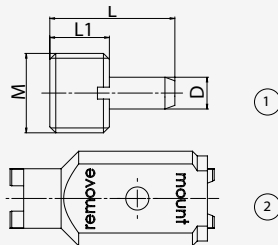

Bestell-Nr. / Order number/ Code	PSC	M	L	L1	D	Typ	kg
PS4.ER1.014.026	40	14x1.5	26	12	6	1	0.01
PS4.ER4.002.090	40					2	0.10
PS5.ER1.016.029	50	16x1.5	29	14	7	1	0.02
PS5.ER4.002.090	50					2	0.10
PS6.ER4.001.087	63	20x2	31.5	15	8	1	0.02
PS6.ER4.002.090	63					2	0.10

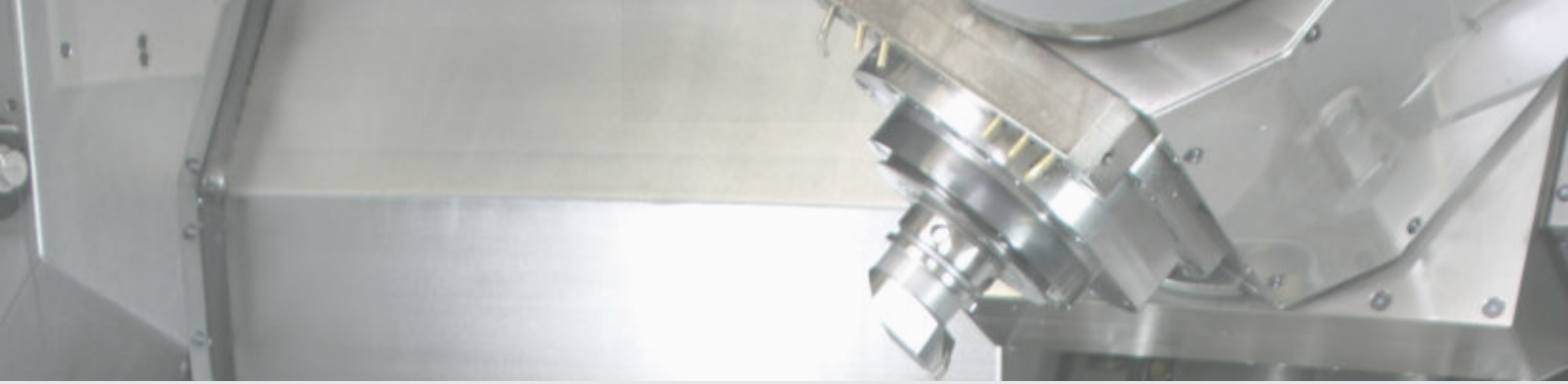

**QUICK-CHANGE** Werkzeugsysteme  
für Multi-Task und Drehmaschinen

**QUICK-CHANGE** tool system for  
multi-tasking and turning lathes

**QUICK-CHANGE** système pour tours  
et pour centre de tournage/fraisage

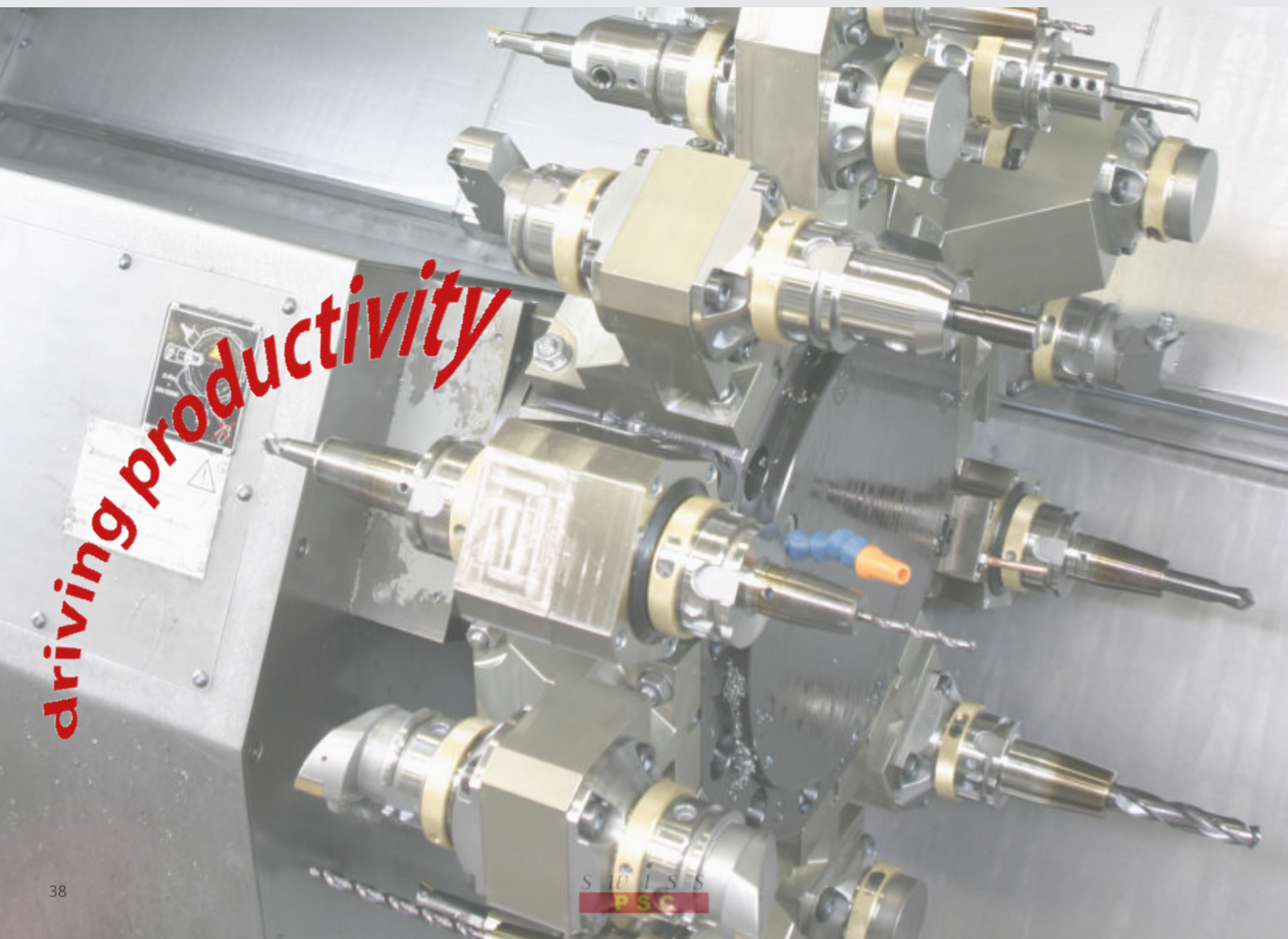

# Systemlösungen / System solution / Solution de système

- Produktivitätssteigerung durch Reduktion der Nebenzeiten.
- Werkzeugwechsel in kürzester Zeit
- Beste Wiederholgenauigkeit mit definierten, gleichbleibenden Werkzeugkonturen
- Für alle Maschinentypen geeignet.
- Flexibel für HSK, PSC und KM Werkzeuge
- Kosteneffizient System

- Increase productivity by reducing non-productive time
- Very quick tool changing time
- Perfect repeatability with fixed tool geometry
- Useable for all machine brands
- Flexible with HSK, PSC and KM tools
- Cost efficient

- Augmenter la productivité en réduisant le temps de non-production.
- Temps de changement d'outil très rapide
- Répétabilité parfaite avec une géométrie d'outil fixe
- Convient à tous les types de machines
- Flexible avec les outils HSK, PSC et KM
- Système rentable

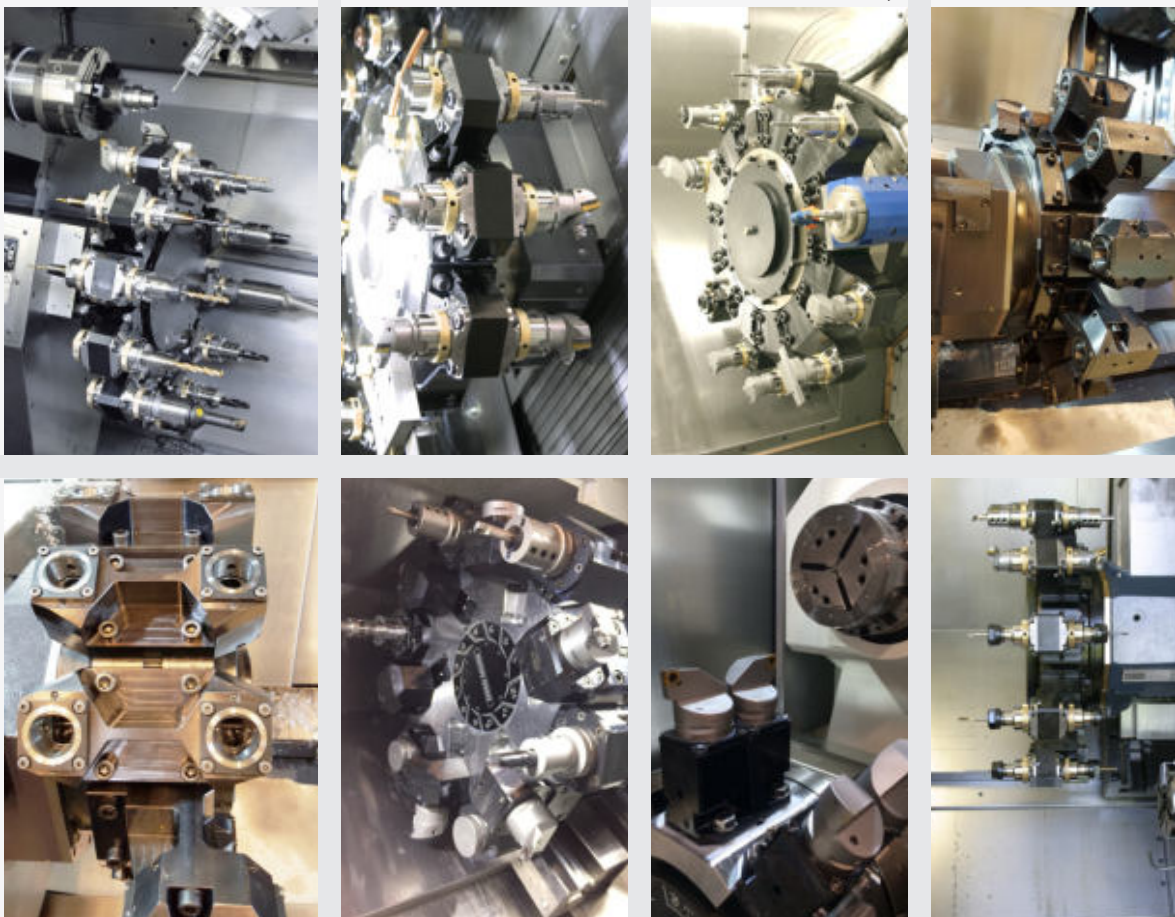

- Online Konfigurator
- Angetriebene- und statische Werkzeuge für Drehmaschinen
- [www.swisstools.org](http://www.swisstools.org)

- Online configurator
- for static and rotating tools
- [www.swisstools.org](http://www.swisstools.org)

- Configurateur online
- pour les outils statiques et tournants
- [www.swisstools.org](http://www.swisstools.org)

# Adaptionsmöglichkeiten Drehrevolverscheiben / Adaptation to turrets / Adaptation à la tourelle

## Werkzeughalter mit Schnellwechselsystem

Das Werkzeughalterprogramm umfasst innovative und technisch ausgereifte Lösungen für alle gängigen CNC-Drehzentren. Wir bieten Ihnen Lösungen, die optimal auf das Maschinenfabrikat abgestimmt sind, ob mit BMT/ VDI oder anderen Anbindungen. Die Schnittstelle des Schnellwechselsystems ist DIN/ISO normiert, und für die Größen HSK 40/63/100, PSC40/50/63 und KM 40/50/63 vorhanden. Der Werkzeugwechsel ist einfach und schnell durchführbar. Die Nebenzeiten werden minimiert und damit die Produktivität gesteigert.

## Tool holder with QUICK-CHANGE system

The whole range of the system contains solutions for the most CNC lathes centres. Complementary on the machine tool with BMT / VDI or other connections. The tool connection is based on DIN/ISO standards with HSK 40/63/100, PSC40/50/63 and KM 40/50/63. The tool change is very simple and quick. Non-productive times are minimized and the productivity will increase.

## Porte-outil avec système de changement rapide

Le programme de porte-outils comprend des solutions innovantes et techniquement sophistiquées pour tous les centres de tournage CNC courants. Nous vous proposons des solutions, adaptées de manière optimale à la marque de la machine, que ce soit avec des connexions BMT/ VDI ou autres. L'interface du système de changement rapide est normalisée DIN/ISO et disponible pour les tailles HSK 40/63/100, PSC40/50/63 et KM 40/50/63. Le changement d'outil peut être effectué facilement et rapidement. Le temps de non-productivité sera minimisé et la productivité est ainsi augmentée.

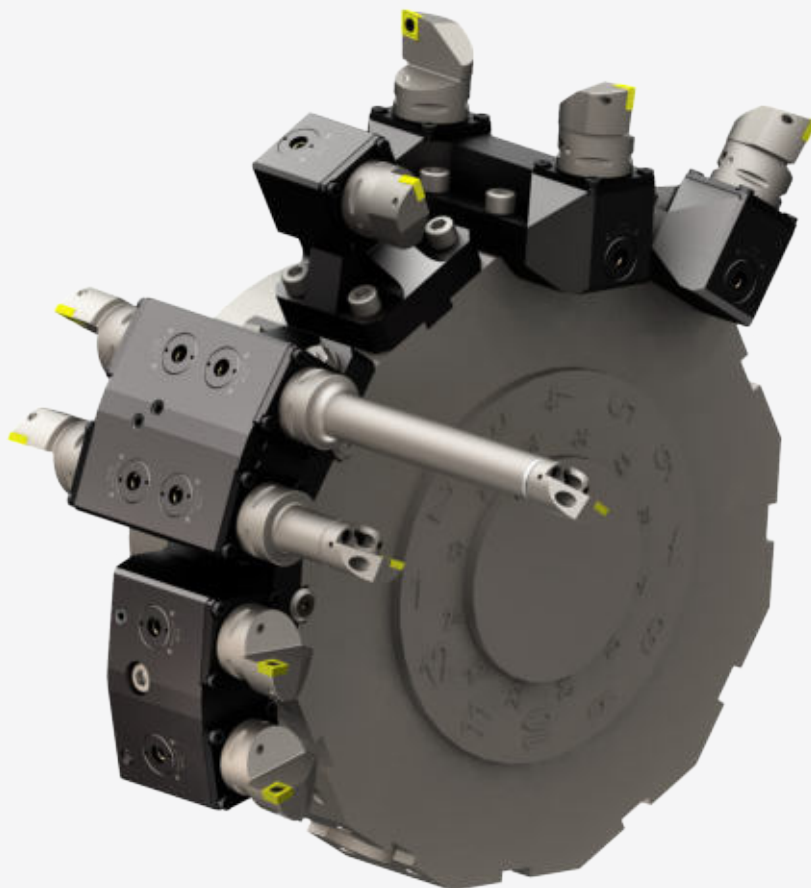



# Werkzeughalter / Tool holders / Porte-outils

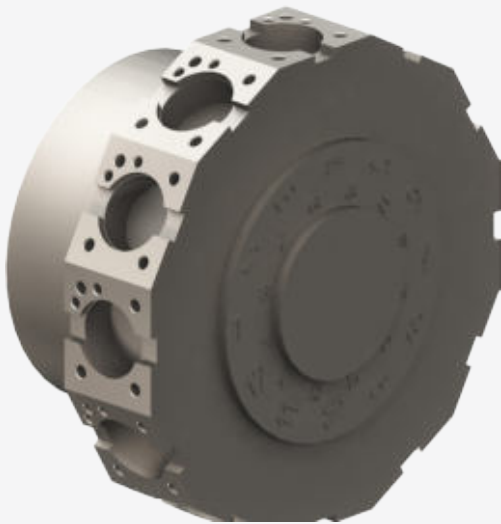

Revolverscheibe /  
Turret/ Tourelle  
BMT/VDI/...



Werkzeughalter  
einfach gerade

Tool holder  
single straight

Porte-outils  
single droit



Werkzeughalter  
doppelt gerade

Tool holder  
double straight

Porte-outils  
double droit



Werkzeughalter  
einfach abgewinkelt

Tool holder  
single angular

Porte-outils  
single angulaire



Werkzeughalter  
doppelt abgewinkelt

Tool holder  
double angular

Porte-outils  
double angulaire

# HSK / PSC / KM Spanneinheiten / HSK / PSC / KM clamping unit / HSK / PSC / KM unités de serrage

Die Werkzeughalter werden entweder mit einer HSK oder einer PSC Spanneinheit ausgerüstet.

Die Werkzeughalter sind somit flexibel auf die Kundenbedürfnisse anpassbar.

Spanneinheiten sind in den Größen HSK 40/63/100, PSC40/50/63 und KM 40/50/63 erhältlich

Tool holders are equipped with HSK or PSC clamping units.

Very flexible for customer needs.

Clamping units are available in HSK 40/63/100, PSC40/50/63 and KM 40/50/63.

Les porte-outils sont soit équipés d'unités de serrage HSK ou PSC.

Les porte-outils sont par conséquent très flexible pour le besoin du client.

Les unités de serrage sont disponibles en HSK 40/63/100, PSC40/50/63 et KM 40/50/63.

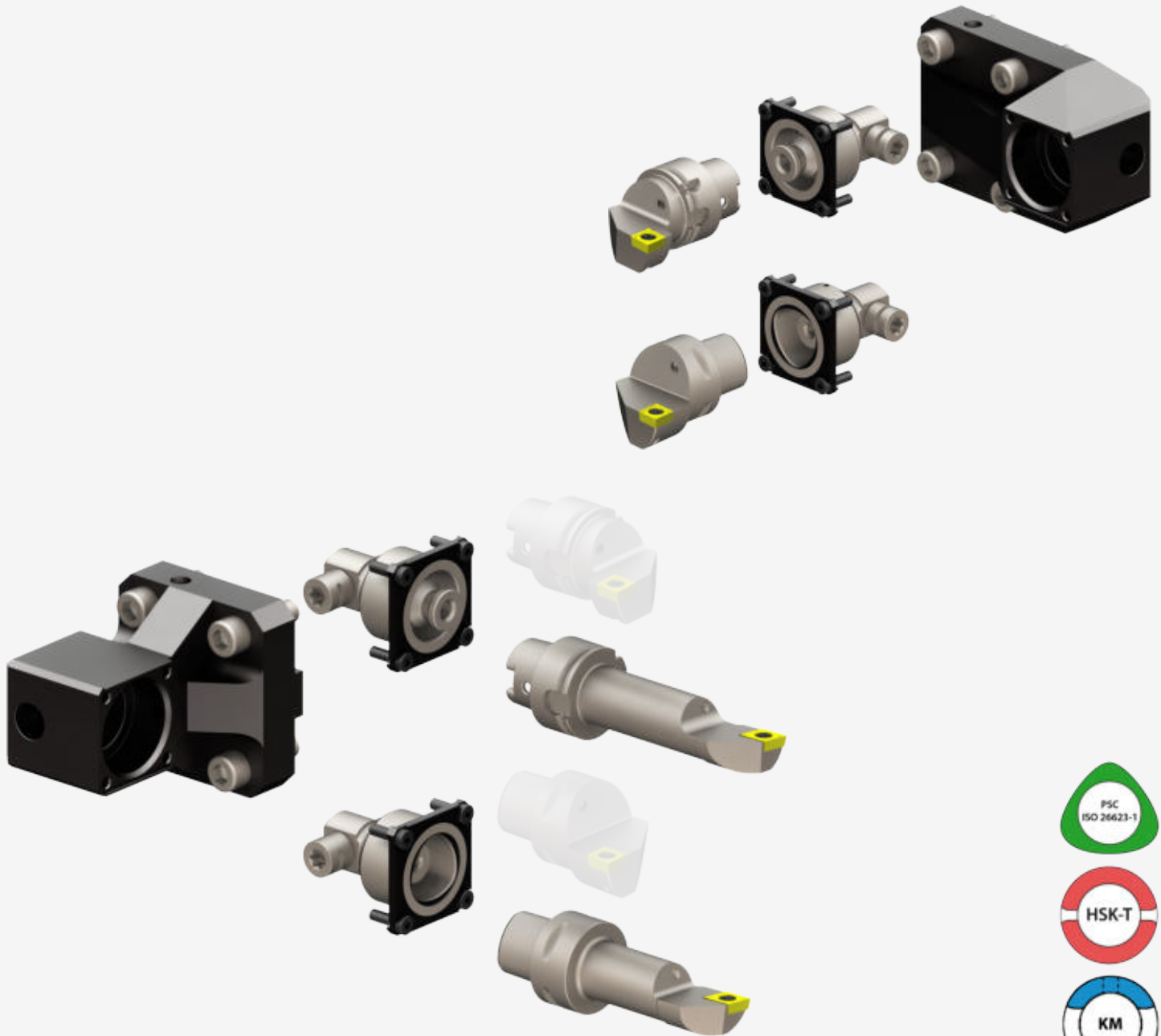

## Quick-Change Werkzeughalter und Spanneinheiten

## Quick-Change Toolholders and clamping units

## Porte-outils et unités de serrage à changement rapide

### Werkzeughalter mit VDI Schaft abgewinkelt / DIN 69880

### Toolholder with VDI shank angular / DIN 69880

### Porte-outils avec tige VDI angulaire / DIN 69880

- Schaft mit Doppelverzahnung R/L Einsatz möglich
- für Innenkühlung

- shank with double serration profile R/L usage possible
- for inner coolant supply

- tige avec double denture, utilisation G/D possible
- pour le arrosage interne

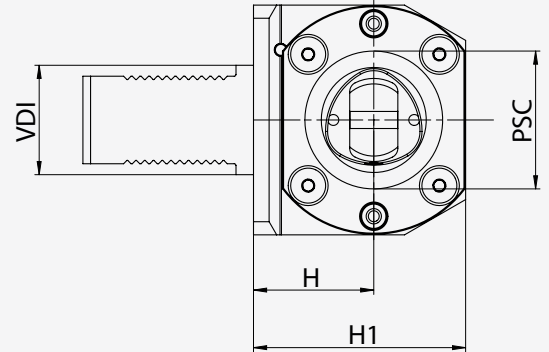
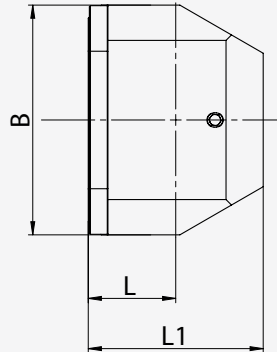
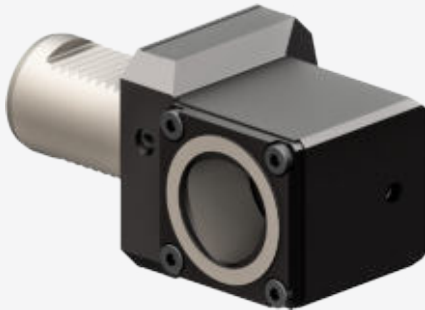

Bestell-Nr. / Order number/ Code	PSC	H	H1	VDI	L	L1	B	kg
REA.PS4.VD3.041	40	41	65	30	21	56	60	2.80
REA.PS4.VD4.051	40	51	75	40	30	86	75	3.00
REA.PS5.VD4.053	50	53	85	40	40	80	86	3.26
REA.PS5.VD5.053	50	53	85	50	40	80	86	3.50
REA.PS6.VD4.053	63	53	95	40	40	80	105	4.80
REA.PS6.VD5.055	63	55	97	50	40	80	105	5.20

### Werkzeughalter mit VDI Schaft gerade / DIN 69880

### Toolholder with VDI shank straight / DIN 69880

### Porte-outils avec tige VDI droite / DIN 69880

- Schaft mit Doppelverzahnung R/L Einsatz möglich
- für Innenkühlung

- shank with double serration profile R/L usage possible
- for inner coolant supply

- tige avec double denture, utilisation G/D possible
- pour le arrosage interne

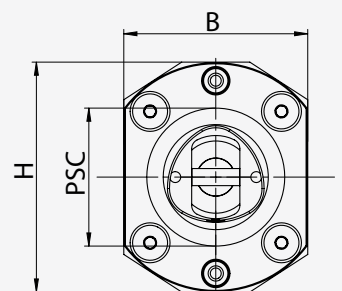
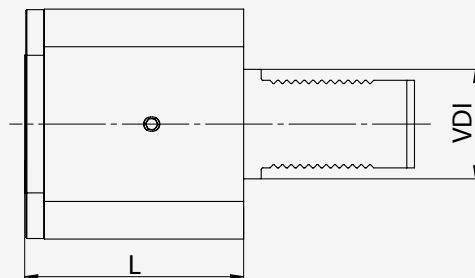
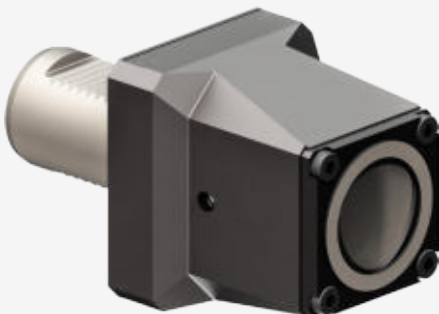

Bestell-Nr. / Order number/ Code	PSC	L	H	VDI	B	kg
RER.PS4.VD3.070	40	70	60	30	52	0.87
RER.PS4.VD4.075	40	75	75	40	75	1.70
RER.PS5.VD4.085	50	85	82	40	75	2.02
RER.PS5.VD5.085	50	85	91	50	83	2.30
RER.PS6.VD4.090	63	90	105	40	84	3.50
RER.PS6.VD5.100	63	100	105	50	84	3.80

## Quadratischer Schaft

- Anschluss für Innenkühlung



## Rectangular shank

- Coupling for inner coolant supply

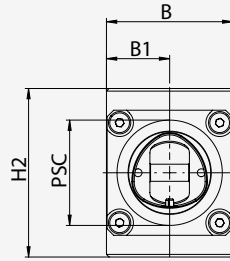

## Porte-outils rectangulaire

- Raccordement pour l'arrosage interne

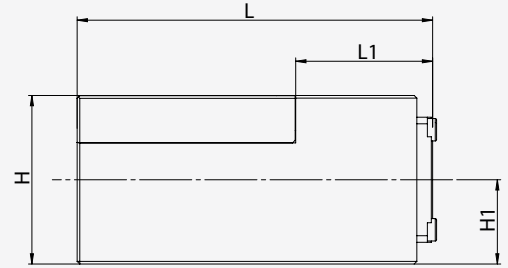

Bestell-Nr. / Order number/ Code	PSC	B	B1	H	H1	H2	L	L1	kg
RER.PS4.V20.140	40	48	24	40	20	58	140	50	
RER.PS4.V25.140	40	48	24	50	25	58	140	57	1.71
RER.PS4.V32.135	40	48	24	64	32	64	135	52	

# PSC

## DIGITALE FEINBOHRWERKZEUGE / DIGITAL FINE BORING HEADS / TÊTES D'ALÉSAGE FIN DIGITALES

- ein Display für alle Feinbohrköpfe  
Ø 0.3 mm - 2205.0 mm
- Anzeige umkehrbar (Links-/ Rechtshänder)
- mm/inch umschaltbar
- Standard AAA Batterie zur Stromversorgung
- Display wird über Magnetkraft am Werkzeug gehalten
- Einstellgenauigkeit 0.001mm im Durchmesser
- direktes Wegmeßsystem (kein Umkehrspiel)
- keine Batterie und Auswerteelektronik im Werkzeug verbaut
- sehr einfache Bedienung
- digital und analog einsetzbar

- one display for all fine boring heads diameter  
0.3 mm – 2205 mm
- display reversible (LH/RH)
- mm/inch switchable
- standard AAA battery required
- display unit will docked with magnetic forces at the tool
- 0.001 accuracy in diameter
- direct measurement system (no backlash)
- no battery and electronic evaluation unit inside the tool
- very easy operation
- for digital and analog use

- un seul display pour toutes les têtes d'alésage fin Ø 0.3 mm - 2205.0 mm
- display réversible (gaucher/droitier)
- mm/pouce commutable
- Pile AAA standard pour l'alimentation
- Le display est maintenu sur l'outil par force magnétique
- Précision de réglage de 0,001 mm sur le diamètre
- système de mesure directe (sans jeu)
- pas de batterie ni de dispositif électronique d'évaluation installé dans l'outil
- fonctionnement très simple
- pour une utilisation numérique et analogique



## Schrumpffutter Typ L

- Standardausführung für hohe Klemmkraft
- für HM- und HSS-Werkzeuge
- Schafttoleranz h6
- Rundlaufgenauigkeit 3 µm
- Aufnahmen feingewuchtet  
G 2.5/25000 U/min
- axiale Längenverstellung

## Heat shrink chuck type L

- standard design for a better clamping force
- for solid carbide and high speed steel tools
- shank tolerance h6
- true running 3 µm
- fine balanced toolholders  
G 2.5/25000 r/min
- axial adjustment

## Porte-outils de frettage type L

- design standard pour une plus grande force de serrage
- pour outils en carbure et en acier High-Speed
- tolérance de tige h6
- runout 3 µm
- porte-outils finement équilibrés G 2.5/25000 t/min
- réglage axial

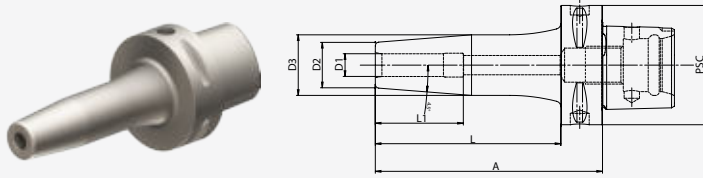

Bestell-Nr. / Order number/ Code	PSC	D1	D2	D3	A	L	L1	kg
PS6.S03.K01.080	63	3	15	20	80	58	-	0.85
PS6.S03.K01.120	63	3	15	20	120	98	-	0.95
PS6.S03.K01.160	63	3	15	20	160	138	-	1.03
PS6.S04.K01.080	63	4	15	20	80	58	-	0.85
PS6.S04.K01.120	63	4	15	20	120	98	-	0.95
PS6.S04.K01.160	63	4	15	20	160	138	-	1.03
PS6.S05.K01.080	63	5	15	20	80	58	-	0.95
PS6.S05.K01.120	63	5	15	20	120	98	-	1.15
PS6.S05.K01.160	63	5	15	20	160	138	-	1.30
PS6.S06.K01.080	63	6	21	26	80	58	36	0.95
PS6.S06.K01.120	63	6	21	26	120	98	36	1.12
PS6.S06.K01.160	63	6	21	26	160	138	36	1.30
PS6.S08.K01.080	63	8	21	26	80	58	36	0.95
PS6.S08.K01.120	63	8	21	26	120	98	36	1.13
PS6.S08.K01.160	63	8	21	26	160	138	36	1.29
PS6.S10.K01.080	63	10	24	30	80	58	41	1.00
PS6.S10.K01.120	63	10	24	30	120	98	41	1.26
PS6.S10.K01.160	63	10	24	30	160	138	41	1.50
PS6.S12.K01.080	63	12	24	30	80	58	46	0.98
PS6.S12.K01.120	63	12	24	30	120	98	46	1.25
PS6.S12.K01.160	63	12	24	30	160	138	46	1.48
PS6.S16.K01.085	63	16	27	34	85	63	49	1.04
PS6.S16.K01.120	63	16	27	34	120	98	49	1.30
PS6.S16.K01.160	63	16	27	34	160	138	49	1.56
PS6.S20.K01.085	63	20	33	41	85	63	51	1.10
PS6.S20.K01.120	63	20	33	41	120	98	51	1.55
PS6.S20.K01.160	63	20	33	41	160	138	51	1.93

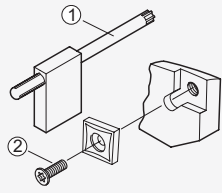

	Typ/ Type	Bestell-Nr. / Order number/ Code <sup>①</sup>	Bestell-Nr. / Order number/ Code <sup>②</sup>
xxx.xCC.xxx.xxx	S01	WCC.ER1.001.000	WCC.ER2.001.010 (5.0 Nm)
xxx.xCD.xxx.xxx	S02	WCC.ER1.001.000	WCC.ER2.001.010 (5.0 Nm)
xxx.xCE.xxx.xxx	S03	WCE.ER1.001.000	WCE.ER2.001.012 (5.0 Nm)
xxx.xWE.xxx.xxx	S04	WCC.ER1.001.000	WCC.ER2.001.010 (5.0 Nm)
xxx.xDB.xxx.xxx	S05	WCB.ER1.001.000	WCB.ER2.001.009 (3.0 Nm)
xxx.xDF.xxx.xxx	S06	WCC.ER1.001.000	WCC.ER2.001.010 (5.0 Nm)
xxx.xVF/VB.xxx.xxx	S07	WCB.ER1.001.000	WCB.ER2.001.009 (3.0 Nm)
xxx.xVD.xxx.xxx	S08	WCB.ER1.001.000	WCB.ER2.001.009 (3.0 Nm)
xxx.xSB.xxx.xxx	S09	WCC.ER1.001.000	WCC.ER2.001.010 (5.0 Nm)
xxx.xVE/VA.xxx.xxx	S10	WCA.ER1.001.000	WCA.ER2.001.006 (0.9 Nm)

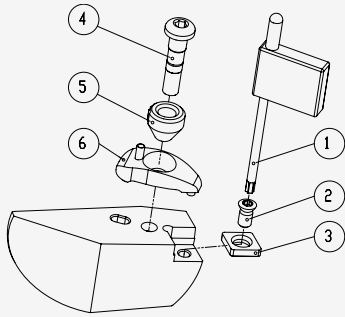

	Typ/ Type	Bestell-Nr. / Order number/ Code <sup>③</sup>	Bestell-Nr. / Order number/ Code <sup>④</sup>	Bestell-Nr. / Order number/ Code <sup>⑤</sup>	Bestell-Nr. / Order number/ Code <sup>⑥</sup>
xxx.xCD.xxx.xxx	D01	WCD.ER2.101.003	WCC.ER4.103.032 (10 Nm)	WCC.ER5.102.012	WCC.ER3.102.024
xxx.KCE.R/Lxx.xxx	D02	WCE.ER2.101.004	WCC.ER4.103.032 (10 Nm)	WCC.ER5.102.012	WCC.ER3.102.024
xxx.KCE.Nxx.xxx	D03	WCE.ER2.101.004	WCC.ER4.103.032 (10 Nm)	WCC.ER5.102.012	WCC.ER3.102.029
xxx.KWE.R/Lxx.xxx	D04	WWE.ER2.101.004	WCC.ER4.103.032 (10 Nm)	WCC.ER5.102.012	WCC.ER3.102.024
xxx.xDF.R/Lxx.xxx	D05	WDF.ER2.101.003	WCC.ER4.103.032 (10 Nm)	WCC.ER5.102.012	WCC.ER3.102.024
xxx.KDF.Nxx.xxx	D06	WDF.ER2.101.003	WCC.ER4.103.032 (10 Nm)	WCC.ER5.102.012	WCC.ER3.102.029
xxx.xVD.R/Lxx.xxx	D07	WVD.ER2.101.003	WCC.ER4.103.032 (10 Nm)	WCC.ER5.102.012	WCC.ER3.102.024
xxx.KVD.Nxx.xxx	D08	WVD.ER2.101.003	WCC.ER4.103.032 (10 Nm)	WCC.ER5.102.012	WCC.ER3.102.029
xxx.KSD.R/Lxx.xxx	D09	WSD.ER2.101.003	WCC.ER4.103.032 (10 Nm)	WCC.ER5.102.012	WCC.ER3.102.024

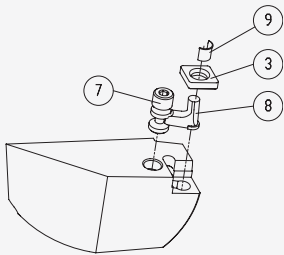

	Typ/ Type	Bestell-Nr. / Order number/ Code <sup>③</sup>	Bestell-Nr. / Order number/ Code <sup>⑦</sup>	Bestell-Nr. / Order number/ Code <sup>⑧</sup>	Bestell-Nr. / Order number/ Code <sup>⑨</sup>
xxx.PCD.xxx.xxx	P01	WCD.ER2.101.003	WCD.ER4.101.017 (5.0 Nm)	WCD.ER3.101.000	WCD.ER1.101.000
xxx.PCE.R/Lxx.xxx	P02	WCE.ER2.101.004	WCE.ER4.101.004 (5.0 Nm)	WCE.ER3.101.000	WCE.ER1.101.000
xxx.PCE.Nxx.xxx	P03	WCE.ER2.101.004	WCE.ER4.101.004 (5.0 Nm)	WCE.ER3.101.000	WCE.ER1.101.000
xxx.PWE.R/Lxx.xxx	P04	WWE.ER2.101.004	WCD.ER4.101.017 (5.0 Nm)	WDF.ER3.101.000	WCD.ER1.101.000
xxx.PDF.R/Lxx.xxx	P05	WDF.ER2.101.003	WCD.ER4.101.017 (5.0 Nm)	WDF.ER3.101.000	WCD.ER1.101.000
xxx.PDF.Nxx.xxx	P06	WDF.ER2.101.003	WCD.ER4.101.017 (5.0 Nm)	WDF.ER3.101.000	WCD.ER1.101.000
xxx.PSD.R/Lxx.xxx	P07	WSD.ER2.101.003	WCD.ER4.101.017 (5.0 Nm)	WCD.ER3.101.000	WCD.ER1.101.000
xxx.PDE.xxx.xxx.xxx	P08	WDE.ER2.101.003	WDE.ER4.101.017 (5.0 Nm)	WDE.ER3.101.000	WDE.ER1.101.000
xxx.PCF.xxx.xxx	P09	WCF.ER2.101.000	WCF.ER4.101.027 (9.0 Nm)	WCF.ER3.101.000	WCF.ER1.101.000
xxx.PSE.xxx.xxx	P10	WSE.ER2.101.004	WCE.ER4.101.004 (5.0 Nm)	WCE.ER3.101.000	WCE.ER1.101.000

PSC 63 | D | C | L | N | R | 45 065 | 12  
1 | 2 | 3 | 4 | 5 | 6 | 7 | 8 | 9

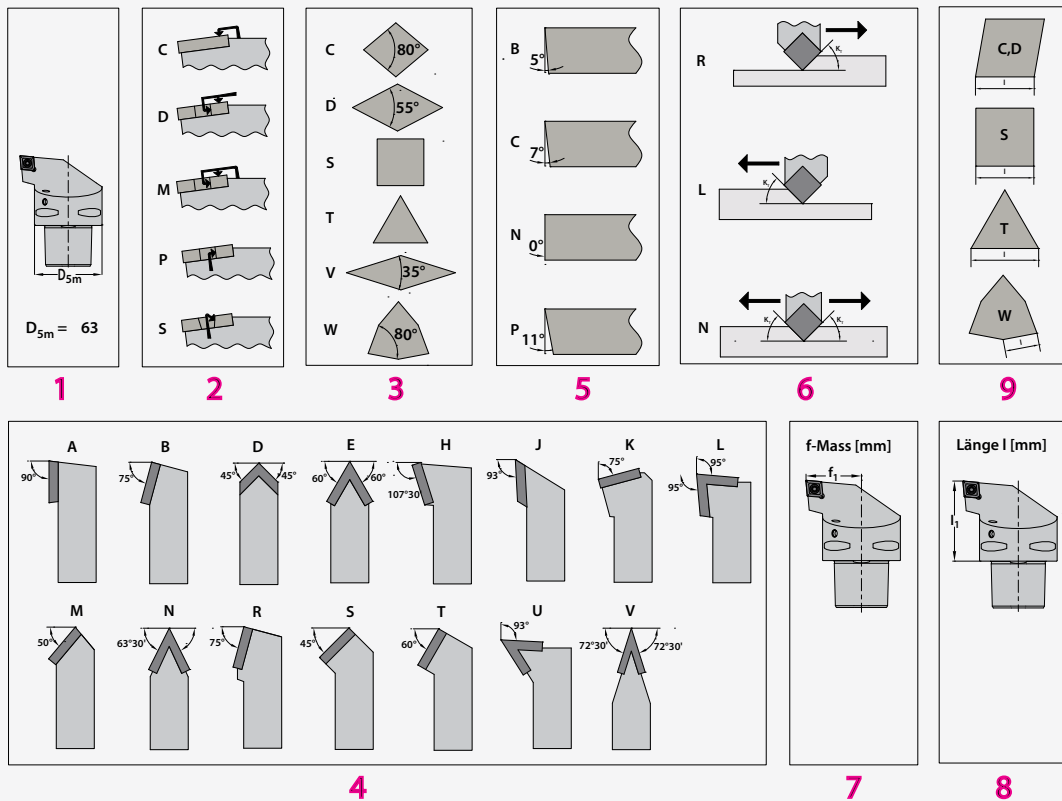

PSC 63 | S | C | L | C | R | - 27180 | - 09  
1 | 2 | 3 | 4 | 5 | 6 | 7 | 8

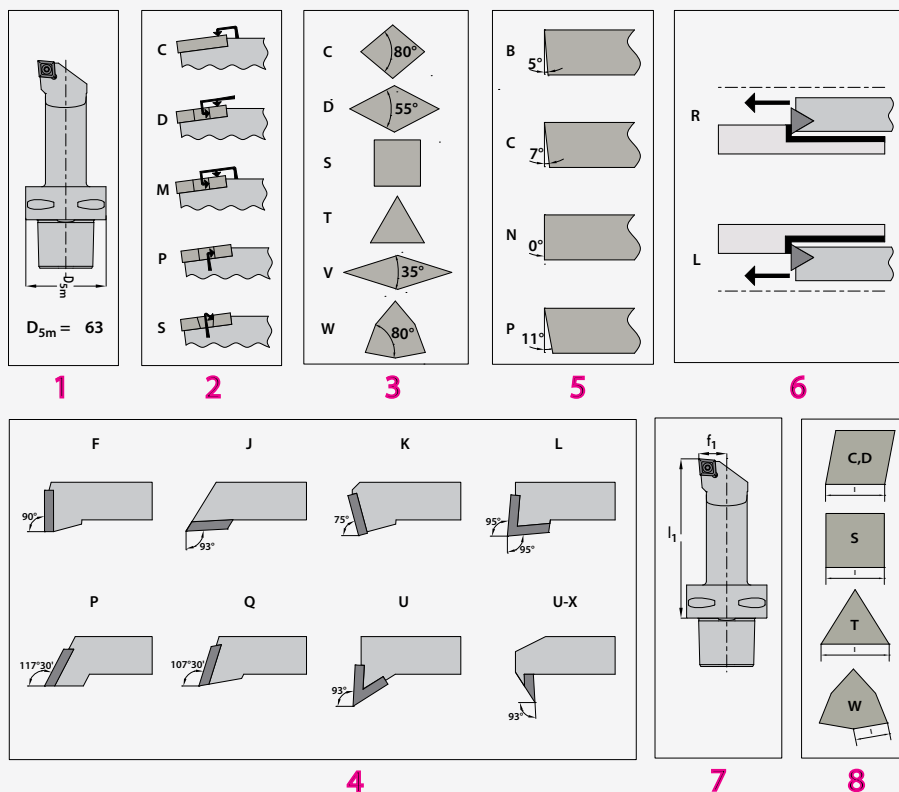

**SWISS**  **TOOLS**<sup>®</sup>  
**SCHAUBLIN**

Swiss Tool Systems AG  
Wydenstrasse 28  
CH-8575 Bürglen  
Phone +41 (0)71 634 85 20  
Fax +41 (0)71 634 85 29  
[www.swisstools.org](http://www.swisstools.org)